

# Combination Oven

MODELS: HE, TE, HG, & TG  
Operator's Manual



# Dear Customer

---

Congratulations on the purchase of your new Combi-King Plus combination oven. By purchasing your new oven, you have entered into a new era of cooking. With the new technology and simplicity built into your new Combi-King combination oven, you will receive excellent results in no time at all. This ease of use will add up in training dollars saved by the simplicity of operation.

In using the Combi-King oven with one touch you will identify the relevant food, you then push start and you are cooking. With the simplicity of operation, you are guaranteed consistently produced products without setting times, temperatures, and finishes.

For the Chef, the Combi King offers a wide array of functions and steps that once tested can be saved and recreated by his staff from the experienced to the first time operator.

## NOTICE

Please read the operations manual in full before starting up the appliance to make sure all the benefits and safety information is understood.

For more information, culinary support, and customer service please contact 1-800-927-6887

Appliance Model \_\_\_\_\_

S/N \_\_\_\_\_

Dealer \_\_\_\_\_

Installer \_\_\_\_\_

Date of Install \_\_\_\_\_



BKI  
2812 Grandview Drive  
Simpsonville, SC 29680  
USA  
<http://www.bkideas.com>

## **BKI LIMITED WARRANTY**

- **2 years standard warranty boiler plate attached adjusted to 2 years**

LIMITED WARRANTIES AND REMEDIES. Seller warrants that at the time of shipment the Products will be free from defects in material and workmanship for a period of no longer than TWO YEAR from the original installation by an authorized representative or no longer than TWO YEAR AND THREE MONTHS from the date of shipment from the factory. Defective conditions caused by abnormal use or misuse lack of or improper maintenance damage by third parties alterations by unauthorized personnel acts of God failure to follow installation and/or operating instructions or any other events beyond the reasonable control of the Seller will NOT be covered under this Warranty. The obligations of the Seller under this warranty shall be limited to repairing or replacing (at the option of the Seller) any part with the exception of lamps, fuses, door gaskets, and glass (which are not covered under this warranty) which is found defective in the reasonable opinion of the Seller. Any part found defective by the Seller will be repaired or replaced without charge F.O.B. factory Simpsonville South Carolina or F.O.B. authorized BKI Distributor. Seller and/or its authorized representatives will assume the normal replacement labor expense for the defective part for the period of the warranty as stated above including reasonable (up to 100 mile or 2 hr round trip) travel time where replacement work is performed during standard business hours and not subject to overtime holiday rates and/or any additional fees. IN NO EVENT SHALL THE SELLER BE LIABLE FOR LOSS OF USE LOSS OF REVENUE OR LOSS OF PRODUCT OR PROFIT OR FOR INDIRECT INCIDENTAL SPECIAL OR CONSEQUENTIAL DAMAGES INCLUDING BUT NOT LIMITED TO FOOD SPOILAGE OR PRODUCT LOSS. THIS WARRANTY DOES NOT COVER GLASS BREAKAGE. THE ABOVE WARRANTY IS EXCLUSIVE AND ALL OTHER WARRANTIES EXPRESS OR IMPLIED ARE EXCLUDED INCLUDING THE IMPLIED WARRANTIES OF MERCHANTABILITY AND FITNESS FOR A PARTICULAR PURPOSE. Any appliance replacement part with the exception of lamps fuses and glass which proves to be defective in material or workmanship within ninety (90) days of installation will be replaced without charge F.O.B. Factory Simpsonville SC or F.O.B. authorized BKI Distributor. The user shall have the responsibility and expense of removing and returning the defective part to the Seller as well as the cost of reinstalling the replacement or repaired part.

## Table of Contents

Table of Contents.....	1
1.0 Introduction .....	2
1.1 Intended Use .....	2
1.2 Safety Precautions .....	3
1.3 Safety Signs and Messages.....	3
1.4 Safe Work Practices .....	4
1.5 Specific Precautions .....	5
1.6 General Safety Guidelines for Installers, Users, and Service Technicians.....	6
1.7 Health and Sanitation Practices .....	7
2.0 Water Quality .....	8
3.0 Product Overview.....	9
4.0 Control Panel.....	10
5.0 Manual Cooking .....	12
5.1 Setting the Temperature:.....	13
5.2 Setting the Time: .....	13
5.3 Power Vent (Convection Mode Only) .....	14
5.4 Fan Speed.....	14
5.5 Probe Cooking .....	15
5.9 Humidity Level (Combination Mode Only) .....	17
5.10 Humidity Level (Steam Mode Only) .....	17
5.11 Pre-Heat .....	18
5.12 Oven Cool Down .....	18
5.13 Rack Control.....	19
6.0 Cleaning.....	20
6.1 Wash Program .....	20
6.2 Cleaning Chemicals.....	21
6.3 Daily .....	22
6.4 Weekly .....	23

## **1.0 Introduction**

### **1.1 Intended Use**

BKI Combi-King Plus combination oven are solely intended for use in commercial applications, especially in commercial kitchens.

The units may only be used for cooking food using the correct racks, containers, baking sheets, and slide in pans. Roll in rack dollies, and cassettes must only be supplied for correct operation only by BKI.

Units may only be used with purest quality drinking water for unit protection. The owner of the oven should test water for filtration needs. Water quality needs can be found in the manual under "Water Quality"

Your new Combi-King oven should not be used for the following purposes, among others:

- As a dishwasher
- As a Smoker oven
- Drying towels, paper, or dishes
- As a storage container
- Heat brines, oils, or other chemicals
- Heating closed containers (i.e. can goods)
- Heating Flammable liquids
- Deep Frying
- Cleaning air filters or equipment parts

---

## 1.2 Safety Precautions

Always follow recommended safety precautions listed in this manual. Below is the safety alert symbol. When you see this symbol on your equipment, be alert to the potential for personal injury or property damage.



## 1.3 Safety Signs and Messages

The following Safety signs and messages are placed in this manual to provide instructions and identify specific areas where potential hazards exist and special precautions should be taken. Know and understand the meaning of these instructions, signs, and messages. Damage to the equipment, death or serious injury to you or other persons may result if these messages are not followed.



This message indicates an imminently hazardous situation which, if not avoided, will result in death or serious injury.



This message indicates a potentially hazardous situation, which, if not avoided, could result in death or serious injury.



This message indicates a potentially hazardous situation, which, if not avoided, may result in minor or moderate injury. It may also be used to alert against unsafe practices.



This message is used when special information, instructions or identification are required relating to procedures, equipment, tools, capacities and other special data.

## 1.4 Safe Work Practices



### **Beware of High Voltage**

This equipment uses high voltage. Serious injury can occur if you or any untrained or unauthorized person installs, services, or repairs this equipment. Always Use an Authorized Service agent to Service Your Equipment



### **Beware of Hot Surfaces. Do Not Touch.**

The door on this unit reaches temperatures that can cause burns. Use caution when opening and closing the door. Do not touch any of the surfaces when the unit is heated.

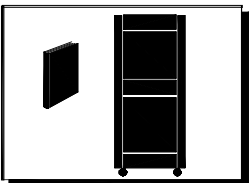

### **Keep this manual with the Equipment**

This manual is an important part of your equipment. Always keep it near for easy access. If you need to replace this manual, contact:

#### ***BKI***

Technical Services Department  
2812 Grandview Drive  
Simpsonville, SC 29680  
Or call toll free: 1-800-927-6887  
Outside the U.S., call 864-963-3471



### **Protect Children**

Keep children away from this equipment. Children may not understand that this equipment is dangerous for them and others.

NEVER allow children to play near or operate your equipment.

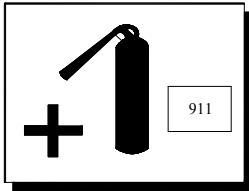

### **Be Prepared for Emergencies**

Be prepared for fires, injuries, or other emergencies.

Keep a first aid kit and a fire extinguisher near the equipment. You must use a 40-pound Type BC fire extinguisher and keep it within 25 feet of your equipment.

Keep emergency numbers for doctors, ambulance services, hospitals, and the fire department near your telephone.

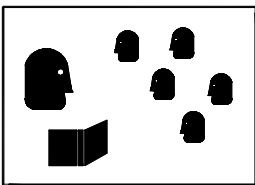

### **Know your responsibilities as an Employer**

- Make certain your employees know how to operate the equipment.
- Make certain your employees are aware of the safety precautions on the equipment and in this manual.
- Make certain that you have thoroughly trained your employees about operating the equipment safely.
- Make certain the equipment is in proper working condition. If you make unauthorized modifications to the equipment, you will reduce the function and safety of the equipment as well as void the warranty.

---

## 1.5 Specific Precautions

**⚠ CAUTION****Equipotential Ground Plane**

When a high current flows through a conductor, differences in potential appear between the conductor and nearby metallic surfaces near the appliance. As a result, sparks may be produced between the appliance and surrounding metal surfaces. These sparks could cause serious injury, damage, or fire.

BKI provides an Equipotential ground terminal for the connection of a bonding conductor after the installation of the appliance per IEC60417-1. This terminal is located on the inside of the Power Entry Supply box near the Earth connection and is marked with this symbol.

**⚠ WARNING**

Disconnect power before servicing.

**⚠ WARNING**

Improper installation, adjustment, alteration, service, or maintenance can cause property damage, injury, or death. Read the installation, operating and maintenance instructions thoroughly before installing or servicing this equipment.

**⚠ WARNING**

Do not connect Combi Steamer-oven drain connection to any drain material that cannot sustain 140° Fahrenheit.

**NOTICE****For Your Safety**

Do not store or use gasoline or other flammable vapors or liquids in the vicinity of this or any other appliance.

**NOTICE**

All service must be performed by a qualified BKI authorized technician.

**NOTICE**

This manual is a part of your new Combi-King Plus combination oven. You must keep and maintain it for the entire life span of your combi and pass it on to the next owner of the unit.

Retain this manual for reference, keep it where you can use it.

This manual may be subject to ne technical developments, modifications, and unforeseen errors.

Do not operate or attempt to operate this appliance or any accessories without reading completely and fully understanding this manual.



## **1.6 General Safety Guidelines for Installers, Users, and Service Technicians**

- Read, understand, and follow the instructions, and heed and obey the warnings of the Installation Manual, the Operator's Manual, and the labels on the Combi, accessories, and supporting products.
- Improper installation, maintenance, cleaning, or modifications to the Combi can lead to injury or death of the operator(s), and equipment and property damage.
- Steam – To avoid steam burns, open the Combi door by turning the handle to the horizontal (“airing”) position and waiting for the steam and condensate to clear. Then stand back and to the hinge side of the door and slowly open the door. Never breathe steam, superheated steam, or hot air. Note: The cooking program is interrupted whenever the door is opened.
- Heat – The Combi, cooking containers, shelves, and inner door and anything else inside the cooking compartment are HOT, as are many of the component parts. Wear DRY heatproof gloves or mitts.
- Exhaust Vents – The top of the Combi, and the gas and steam exhaust vents are very hot during operation and remain hot for some time. Never breathe gas or steam from the exhaust vents. Use extreme caution when working on or near this area and component parts.
- Scalds – Do not place containers with liquid contents or contents that become liquid on oven racks higher than you can see into the containers. Cover containers (individual or on trolleys) containing hot or hot liquid items to help prevent spills during transport. Observe and heed and obey and obey the additional warnings and warning labels posted on the Combi
- Grease Spatter – Hot grease will spatter and cause burns if sprayed with water. Locate fryers and similar appliances outside the range of the Combi hand shower.
- Electric Shock – Use the hand shower only on the inside of the oven. Use of the hand shower, hoses, power cleaners, or pressure washers on the outside of the Combi can cause electric shock and / or damage electrical and electronic components.
- Cleaning and Daily Maintenance – Wait for the Combi to cool before cleaning and performing daily maintenance. Do NOT spray water in a hot cooking compartment. Do not use hoses, power cleaners or pressure washers, or harsh or abrasive cleaning agents inside OR outside the cooking compartment.
- Cleaning Agents – Use only BKI approved cleaning and descaling products. Follow the instructions and heed and obey the warnings on the labels. Other products can damage the Combi, cause injury, or present health hazards.
- Wear SHOES/BOOTS appropriate to the work area to help protect feet, and to help prevent slips and falls.
- Use non-slip, draining, anti-fatigue FLOOR MATS (not included) rated for use in wet, greasy, and dry work areas to help prevent slipping and / or falling injuries. Obtain the best mats for your needs from your local supplier.

## **1.7 Health and Sanitation Practices**

BKI Combi Ovens are manufactured to comply with health regulations and are tested and certified to UL<sup>®</sup>, cUL<sup>®</sup>, and NSF<sup>®</sup> standards. You must operate the equipment properly using only quality products and use meat thermometers to insure meats are thoroughly cooked.

### **Food Handling**

- Wash hands thoroughly in warm, soapy water after handling raw poultry or meats.
- Clean and sanitize all utensils and surfaces that have been in contact with raw products. Clean and sanitize the meat forks or baskets between cooking.
- **Never** place cooked meats on the same surfaces used to prepare raw meats, unless the area has been thoroughly cleaned and sanitized.

### **Storage of Raw Meats**

- Designate an area or shelf strictly for the storage of all raw meats to be used in the rotisserie.
- Raw product must always be stored at temperatures below 38° F. (3° C.).
- **Never** store or mix raw foods above cooked foods, as this is a health hazard. The drippings from raw foods contaminate cooked or processed foods.
- All chicken and chicken parts to be stored overnight must be thoroughly iced down and refrigerated.

### **Coding Cooked Foods**

- All products cooked during the day should be sold the same day.

**NOTE:** Follow your company's procedures for the handling of any leftover product.

### **Storage of Prepared Foods**

- Cold foods should be kept at or below 38° F. (3° C.).
- Hot foods must be maintained to meet local health codes, usually a minimum 145° F. (63°C.).

---

## 2.0 Water Quality

As with all steam related products, water filtration and regular filter replacements may be necessary with the combi. It is strongly recommended to have a water analysis performed prior to installing the combi. Poor water quality can have a big impact on cook quality, performance, and longevity of the combi. Varying combinations of pH; alkalinity; hardness; chlorides; total dissolved solids; and other chemical characteristics, when subjected to high temperatures, will cause water to have a tendency to either scale or corrode.

There are a number of different water filter/treatment systems out there and each has its own benefits and specialties. Below are a couple different styles and their benefits. Multiple styles may need to be used to get the water to proper levels.

### A) Particle Filter

When the water contains sand, iron particles or suspended matter, we recommend a 5-15  $\mu\text{m}$  (micrometer) particle filter:

### B) Active Carbon Filter

When the level of chlorine ( $\text{Cl}_2$ ) in the water exceeds 0.5 mg/L (= ppm) (information available from the water company), an active carbon filter should be installed.

### C) Phosphate Additive System

A Phosphate Additive (Feeder) System is recommended for steam generator units only when a moderate level of scale (not containing chloride) is experienced. System recommended Kleensteam from Everupure.

### D) Ion Exchange System

An ion exchange system is recommended for a steam generator based unit when a high level of scale (not containing chloride) is experienced and for a spritzer based unit when the any scale (not containing chloride) is experienced.. Systems recommended: Claris from Everpure (H+ Ion Exchanger). Sodium ion exchangers (as used in dishwashers) must not be used.

### E) Blended Reverse Osmosis (RO)

When the water has a chloride  $\text{Cl}^-$  concentration above 20 mg/L (= 20 ppm), a blended RO system should be installed to avoid corrosion.

Note: Make sure a minimum conductivity of 20  $\mu\text{S}/\text{cm}$  (microSiemens) remains in the water for steam generator units.

Water quality must conform to the below requirements. If water does not meet the minimum quality, if damage to the oven is determined to be due to water quality it will be considered non-warranty, and not covered under the stated warranty policy.

## BKI Minimum Water Quality Requirements

- Hardness ( $\text{CaCO}_3$ ) = Less than 7.5 GPG (Grains per Gallon)
- TDS (Total Dissolved Solids) = Less than 100.0 mg/L (Milligrams per Liter)
- Free Chlorine = Less than 0.5 mg/L (Milligrams per Liter)
- Chlorides = Less than 20 mg/L (Milligrams per Liter)
- Chloramines = Less than 0.5 mg/L (Milligrams per Liter)
- Total Alkalinity = Less than 20 mg/L (Milligrams per Liter)
- Total Silica = Less than 10 mg/L (Milligrams per Liter)
- pH level = 7.0 to 8.0
- Conductivity (Boiler Models only) = Minimum of 20  $\mu\text{S}/\text{cm}$  (microSiemens per cm)

### 3.0 Product Overview

1. **Control Panel**
2. **Door Handle**
  - Left to vent position
  - Right to open
3. **Oven Lights**
  - On the door
4. **Hose Reel**
  - Behind the door on table top units
5. **Side Panel**
  - Removable for service access
6. **USB Port**
7. **Core Temperature Port**
  - Removable on table top unit only
8. **Legs**
  - 4" adjustable for table tops
  - 6" adjustable for floor models
9. **Rating Plate (on Back Corner)**
  - Contains the following information:
    - Model Number
    - Serial Number
    - Voltage
    - Power Consumption
    - Amp Draw
    - Breaker Size
    - Phase
    - Frequency
10. **Door Trip Tray**
  - Behind Door
  - Built in Trolley on Floor Models
11. **Control Panel Air Filter**

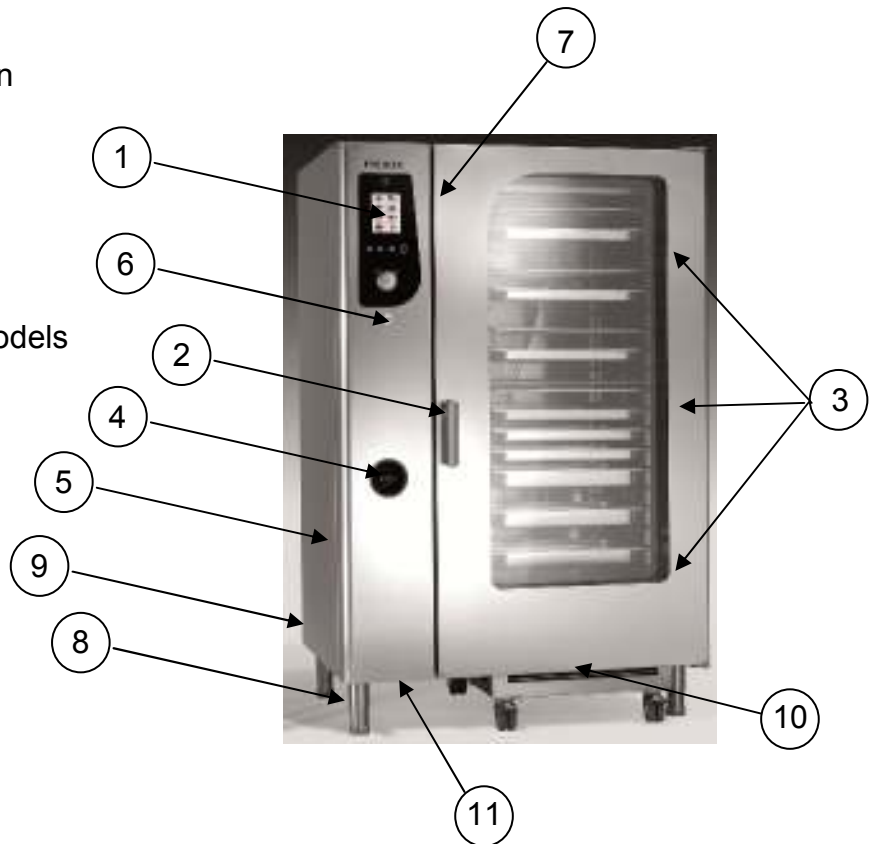
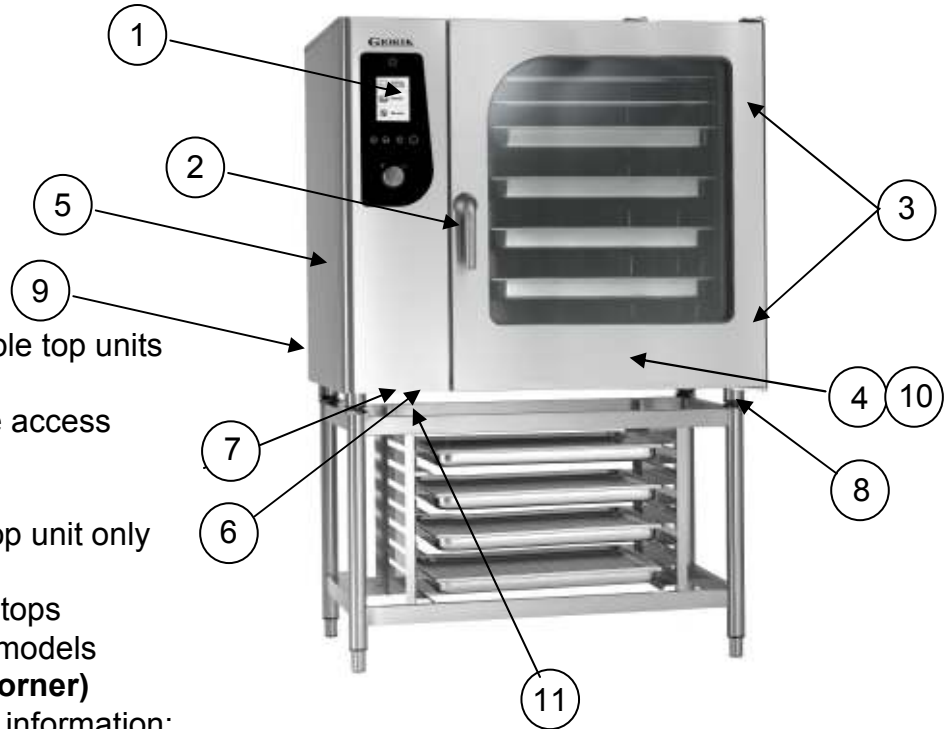

## 4.0 Control Panel

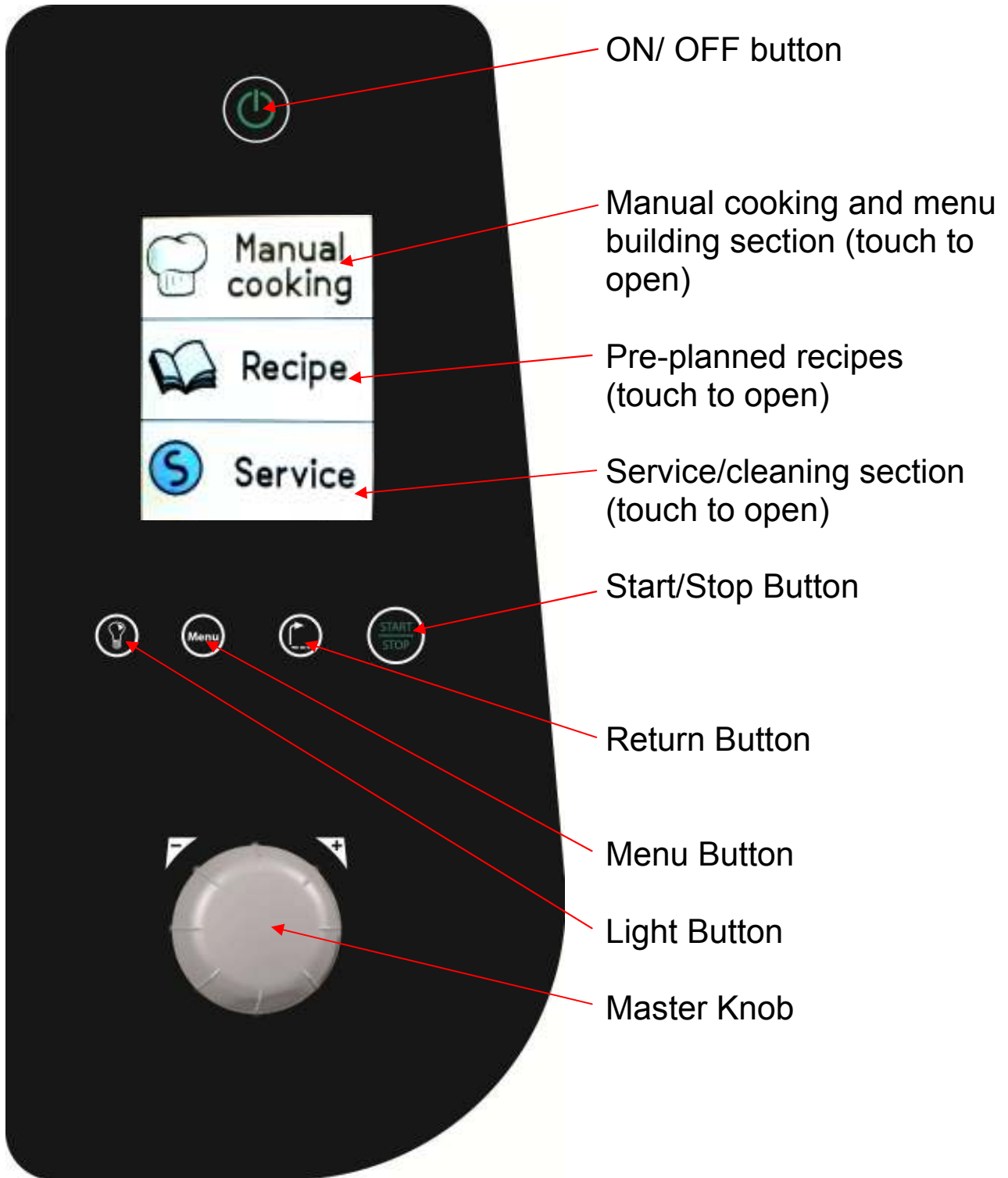

---

## Control Panel

**ON/OFF Button:**

Turns the unit on/off. Press and hold for 3 seconds. On steam generator units, it fills and drains the steam generator.

**Light Button:**

Toggles cavity light on and off. The light will automatically switch off after 45 seconds.

**Menu Button:**

Returns to the main menu.

**Return Button:**

Returns to previous screen.

**START/STOP Button:**

Start/stops the cooking program.

**Master Knob:**

Used for entering and changing parameters. The knob can be pressed to select a function or confirm a parameter. The knob can turn freely in either direction, turning clockwise will increase values.

## 5.0 Manual Cooking

From initial Menu, push “Manual cooking” which will bring you to the manual screen.

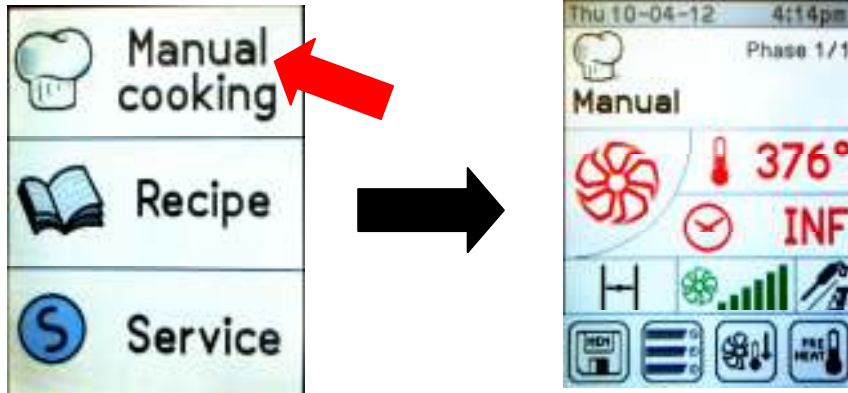

Push the fan icon on the screen that opens a selection with the four cooking mode choices:

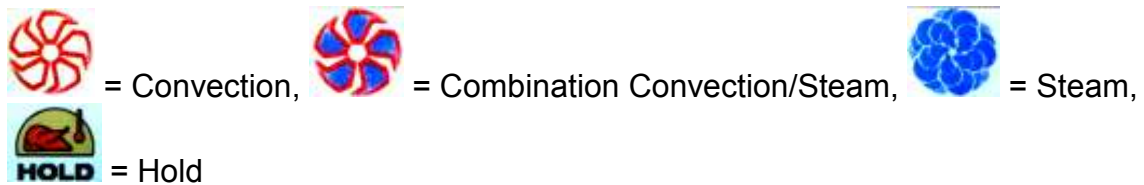
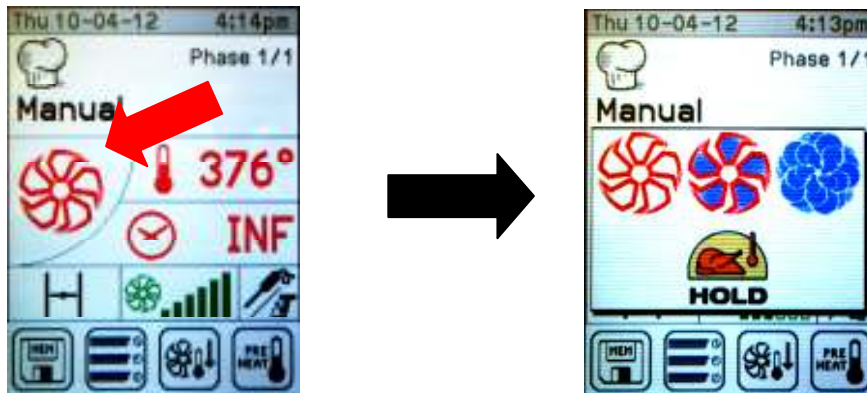

Select the mode by pressing the desired icon.

Operating ranges:

Convection - 122° F (50° C) to 572° F (300° C)

Combi - 122° F (50° C) to 518° F (270° C)

Steam - 122° F (50° C) to 248° F (120° C)

The screen will show the chosen mode, and you are now ready to adjust the cooking parameters.



### 5.1 Setting the Temperature:

Select the temperature setting on display by pushing the temperature screen. choose the temperature by turning the Master Knob. Confirm by pressing Master Knob or the display.

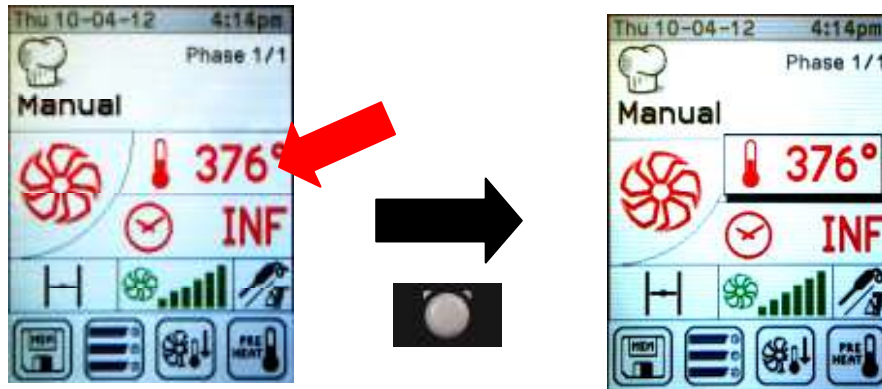

### 5.2 Setting the Time:

The oven can be programmed for cooking cycles that vary from 1 minute to 120 minutes. The oven also has an infinite setting.

Select the time setting on the display by pressing the time screen, then turning the Master Knob until you reach correct cooking time. To set infinite time, turn the Master Knob counterclockwise until "INF" appears.

To set the time, push the Master Knob or the display.

Upon completion of cooking time the oven automatically stops taking itself to "stand-by" mode, and emits a warning signal for about 15 seconds.





### 5.3 Power Vent (Convection Mode Only)

The power vent is used for evacuating humidity during cooking cycles and cooling in between cooking steps. The butterfly valve will open or close as programmed. The vent is always in the closed position unless activated and opened. It must be programmed in Convection only. In Steam and Combi modes, it is controlled by the oven.

Select the power vent on the display by pressing the vent box. Pressing the box toggles the vent open and closed.



### 5.4 Fan Speed

To select the fan speed setting for the convection fan(s) push the fan box on the screen. Move the boxes to the right or left to increase to speed 6 or decrease to speed 1 using the Master Knob. Push the Master Knob or the fan box to confirm the choice.



### 5.5 Probe Cooking

To select Core Probe or  $\Delta T$  cooking press Core/ $\Delta T$  box

That opens a selection window with two options: Select the wanted mode by pressing the display.

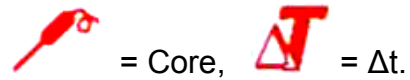

### 5.6 Core Temperature Probe

For core probe cooking, the core temperature determines the cooking time based on the temperature measured by the core probe. To set the core probe temperature (the finished internal temperature of the food product being cooked), select the probe temperature on the display by pressing the probe symbol, then turning the Master Knob until the desired finished internal cooking temperature is reached. Confirm by pressing Master Knob or the display. The cooking stops the moment the temperature of the product being cooked reaches the set core temperature.



## 5.7 Delta T

For  $\Delta t$  cooking, the temperature in the cooking chamber is based on the temperature measured by the core temperature probe. Setting a  $\Delta t$  value equal to 100°F for example, the temperature in the chamber will be maintained constantly 100°F above what is detected at the core of the product. Cooking will stop when temperature of the product being cooked, measured by the core probe, reaches the set value. Set both the  $\Delta t$  and core probe temperature by selecting the icon and turning the Master Knob until the desired temperature is reached. Confirm by pressing Master Knob or the display.

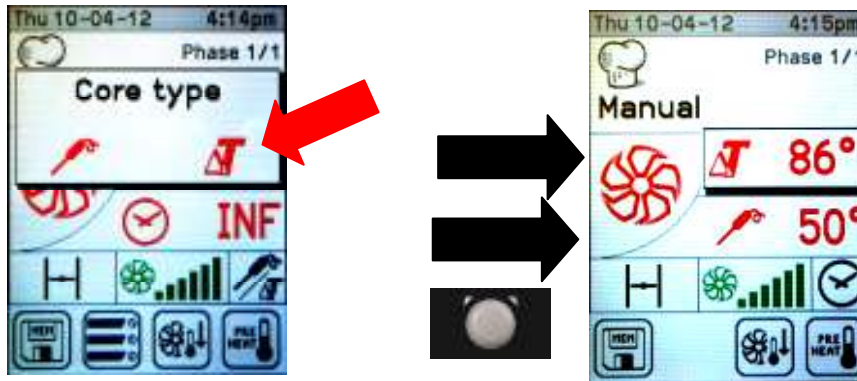

## 5.8 Add Moisture (Convection Mode Only)

In a cooking mode it is possible to manually inject humidity into the cooking chamber using the Humidifier function. This is accomplished by keeping the add moisture key pressed for as long as moisture is desired in the cooking chamber.

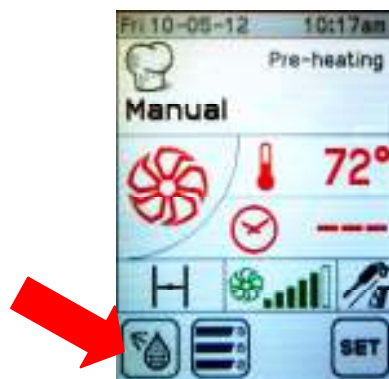

## 5.9 Humidity Level (Combination Mode Only)

In combination convection-steam cooking mode it is possible to set the percentage of humidity present in the cooking chamber by pressing the humidity percentage box and rotating the Master Knob to increase or decrease moisture by 5 % from 5% to 100%. Confirm by pressing Master Knob or the display.



## 5.10 Humidity Level (Steam Mode Only)

Selecting the steam cooking mode the STEAM TUNER function activates. With the indicator bar in the central position it indicates optimal steam regulation in the cooking chamber and guarantees 100% humidity saturation in the cooking chamber. It is possible to adjust the quantity of steam forced into the chamber by pressing the + or – keys on the STEAM TUNER based on the desired type of cooking. Moving the selector indicator bar towards + will produce a “wetter” steam (for example for cooking potatoes for puree); moving it towards - causes the steam to be more “dry” (for example when preparing fish and delicate products).

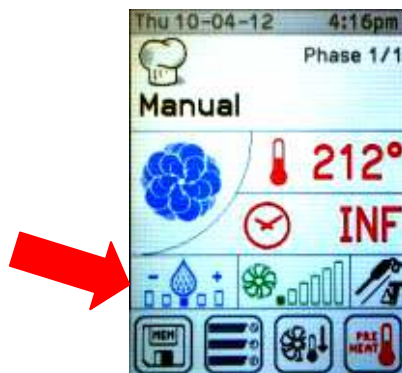

### 5.11 Pre-Heat

Once the oven has been set, the oven pre-heating function can be selected by pressing the pre-heat button. In pre-heating phase, the pre-heat button becomes red colored. The oven automatically determines the pre-heating temperature. When the oven reaches pre-heat temperature, it will signal with an audible warning tone.

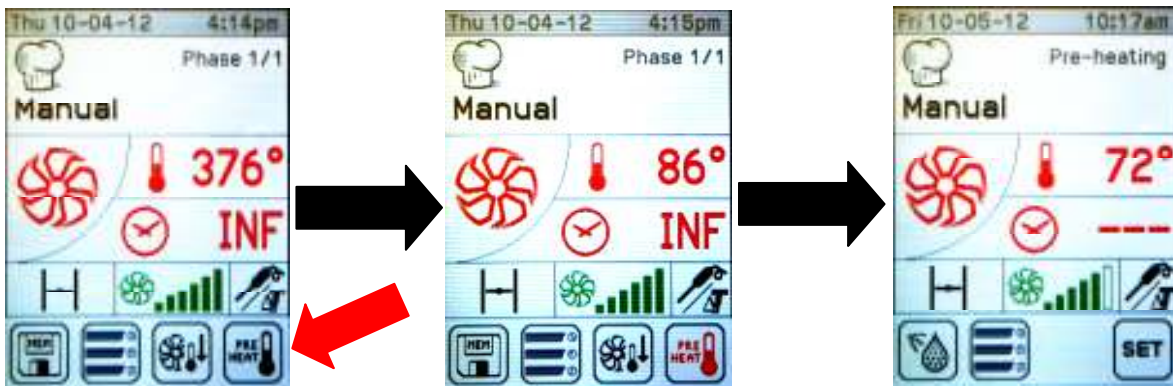

### 5.12 Oven Cool Down

To cool down the cooking chamber after a cooking cycle, activate the cool down mode by pressing the cool down icon on the screen. The cycle will begin immediately.

It is now possible to open the door to assist in cooling down the oven. The power vent will open to assist in cooling as well.

During cooling, the convection fan(s) turn at speed 6. The cooling cycle only starts if cooking chamber temperature exceeds 150°F and ends once a temperature of 122°F is reached or the stop key is pressed. Once cooling is completed, the power vent automatically closes.

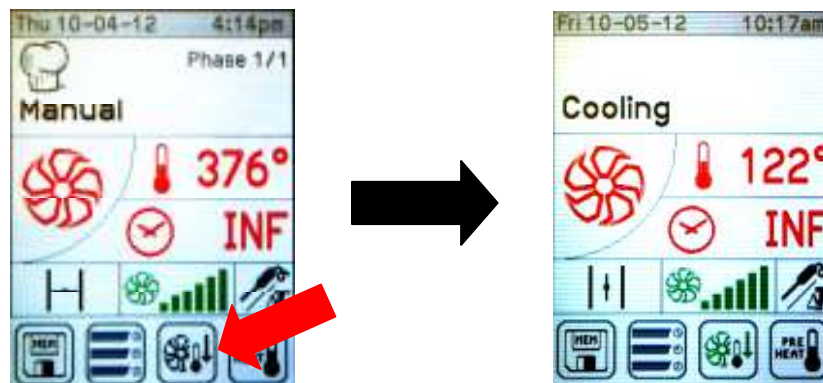



### 5.13 Rack Control

The Rack Control program is for when it is desired to cook different foods in the same cooking mode and temperature or the same foods in a la carte style, such as au gratin, grilled meat, baked fish, etc.

To activate the Rack Control interface, press the Rack Control icon on the screen. The cooking mode, oven temperature, fan speed, and humidity level can all be controlled through this interface by pressing the appropriate icon and using the Master Knob or touch screen.

The screen will show 6, 10, or 20 levels (according to the type of oven). For each level it is possible to set a cooking time or core probe temperature by pressing the desired rack position. Only one level can be set with the core temperature probe at a time. Opening and closing of the door does not affect the cooking time, as it will be regained in proportion of the door opening time. Active level timers will turn red.

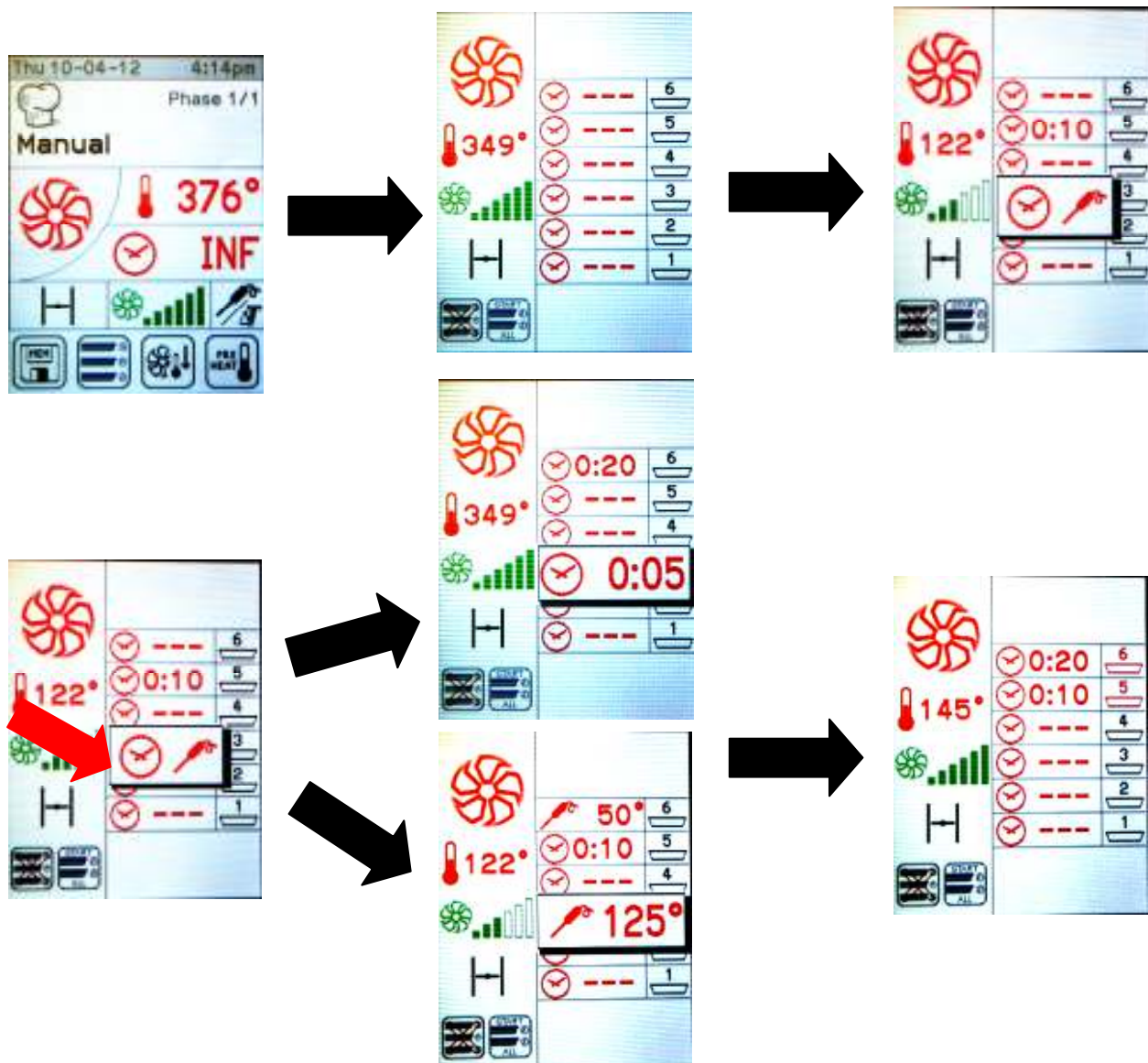

## 6.0 Cleaning

### 6.1 Wash Program

The wash programs are accessed through the SERVICE menu, accessible from the Main menu. Selection of the pre-chosen function is made by turning the Master Knob then pressing it for confirmation or touching the desired selection on the screen. The Washing function enables manual washing of the cooking compartment. The manual washing cycle is made of 4 phases:

- In the first phase, of the duration of 5 minutes, steam is generated in the compartment to dampen the surfaces;
- Upon the acoustic signal warning completion of the first phase, open the oven door and spray the compartment doors with a detergent for ovens. **DO NOT USE CHLORINE BASED PRODUCTS;**
- Close the oven door. A new steam cycle is starting;
- Upon acoustic signal, open the oven door and sufficiently rinse using appropriate spray head.

In ovens equipped with Automatic washing function, the above described phases happen automatically. With this type of ovens, to perform washing, ensure the cleaning detergent and rinse aid are connected to the pump and select Cleaning. The 4 automatic washing levels (Hard, Intense, Normal, Soft) are selected based on the degree of cleaning necessary to remove cooking residue in the compartment (Hard=deep cleaning, for very resistant filth, Soft=light washing).

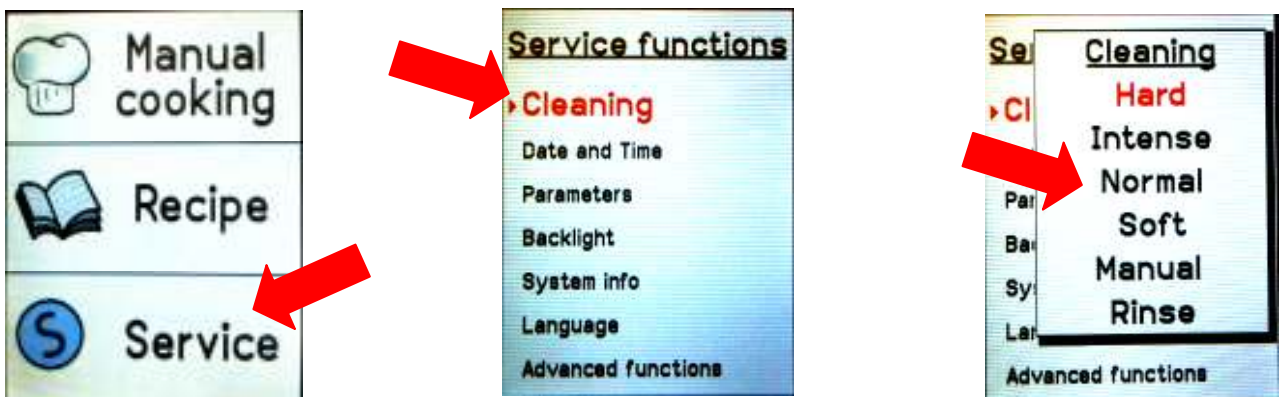

---

## 6.2 Cleaning Chemicals

Use only BKI approved cleaning agents to clean the oven interior.

Unauthorized cleaning agents may discolor or harm interior surfaces of the oven. Read and understand label and material safety data sheet before using the oven cleaner and rinse aid.

Always use protective gloves and eyewear when handling any chemical including wash or rinse liquids.

Use and follow all directions supplied by the manufacturer of the liquids listed on the containers and as instructed by your manager.

Observe all rules for storage of chemicals supplied by the chemical manufacturer.

Do not use unauthorized abrasive cleaners on the oven for any reason including any wire or metal scrapers, or pressure washing of any kind.

**Note:**

Damage caused to any surface, gasket, or part due to abrasive chemicals or tools because of improper cleaning or without using the specified cleaning agents will invalidate any warranty claims.

Detergent must contain less than 5% (by weight) Sodium Hydroxide.

If the combi is equipped with the automatic cleaning system, the cleaning hoses will be pre attached to the unit. Please take care placing the correct hose in the correct chemical. The clear hose is for the cleaning detergent and the red hose is for the rinse aid.

**BKI Approved Cleaning Chemicals:**

Detergent – ECOLAB Greasecutter Plus

Rinse Aid: - ECOLAB R/O Free Rinse Additive

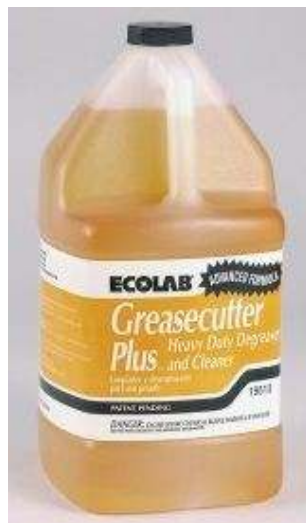

**Detergent**



**Rinse Aid**



---

### 6.3 Daily

- At the end of a working day, clean the equipment, both for hygienic reasons and to avoid malfunctioning.
- The oven must never be cleaned using direct or high pressure water jets.
- Never use pan-scrubbers, steel brushes, or scrapers or abrasive cleaners to clean the inside or outside of the oven to clean
- Wait for the cooking compartment to cool down.
- Remove the side tray racks. Clean by hand or in dish washer
- To clean the oven external parts, use a damp cloth and a non-aggressive cleaner
- Clean all 4 sides of the glass on the door see illustration



---

### 6.4 Weekly

The filter under the control panel that filters the air that cools the boards must be cleaned weekly. It is found under the edge of the control panel see below . Pull down on the bent metal handle to remove grate and remove filter, wash in warm soapy water and let dry. Return the filter to its space and reinstall the grate

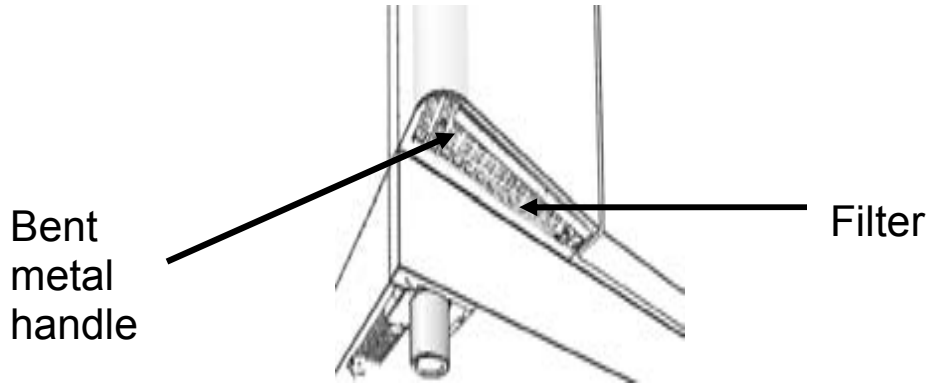

The steam/humidity stack has to be checked weekly to observe any obstructions in the pipe.

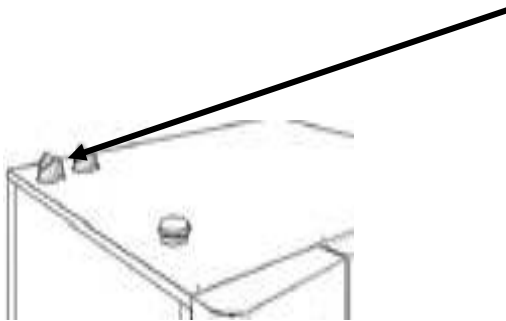





2812 Grandview Drive, Simpsonville, SC 29680, USA  
<http://www.bkideas.com>

Made and printed in the U.S.A