

208 OR 240V

BLACK

WHITE

L1

L2

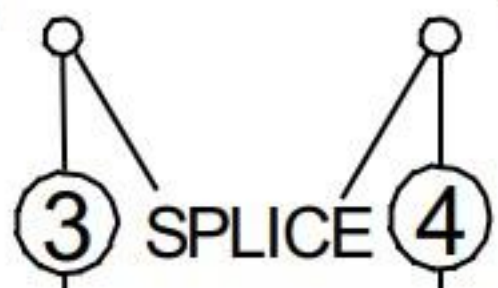
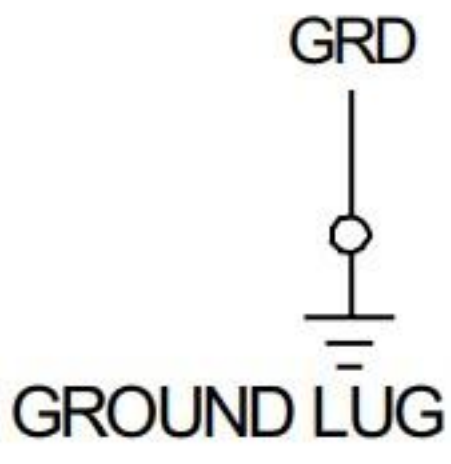

THERMOSTAT

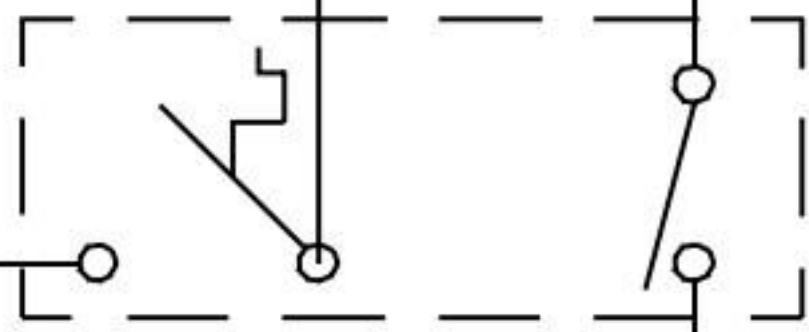

HI-LIMIT SWITCH

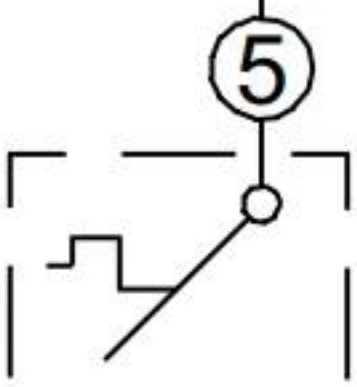

PILOT LIGHT

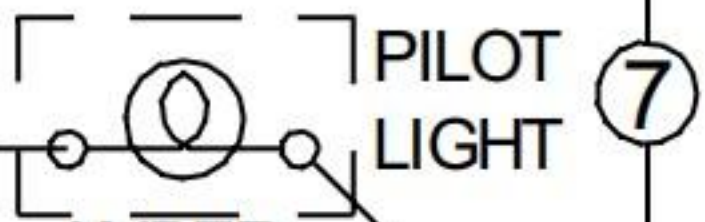

AMBER

6

9

8

HEATING ELEMENT



208 OR 240V

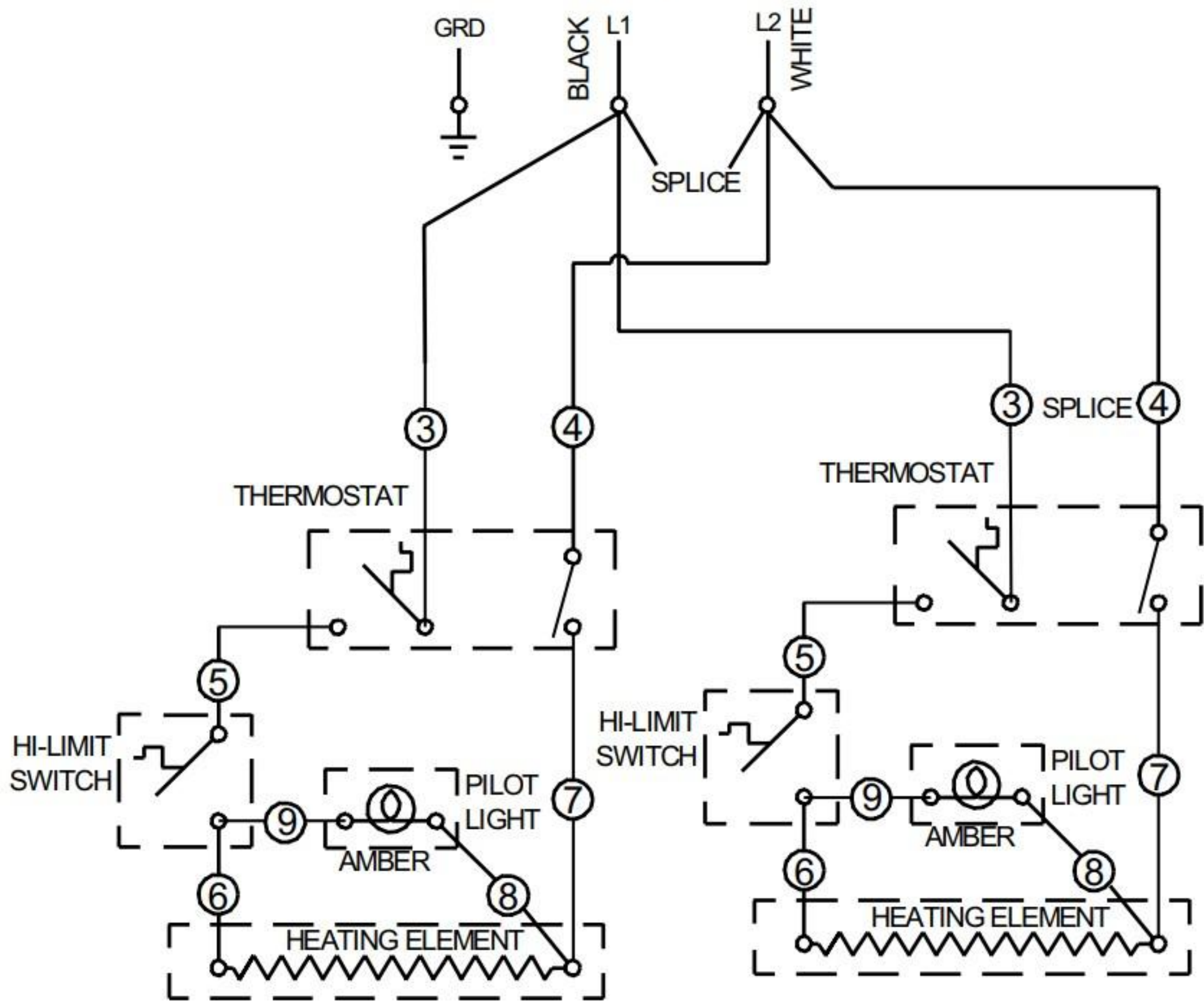

208 OR 240V

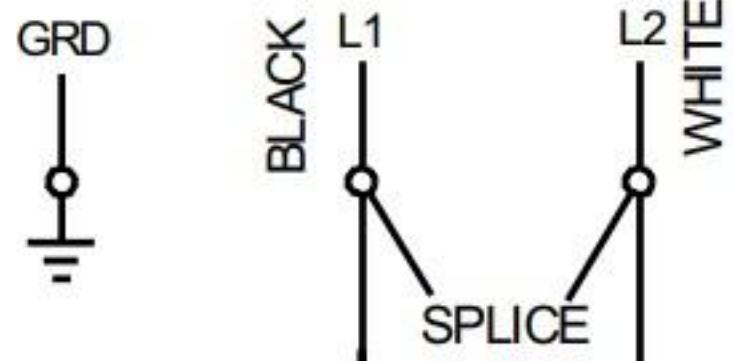

THERMOSTAT

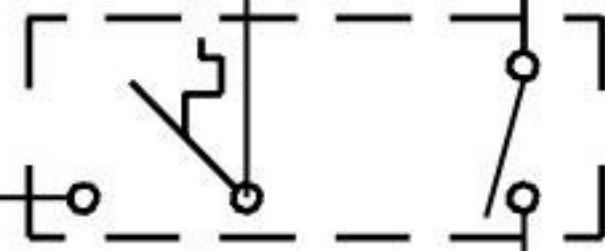

HI-LIMIT SWITCH

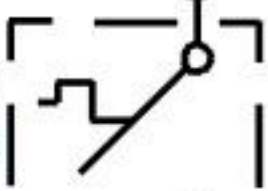

PILOT LIGHT

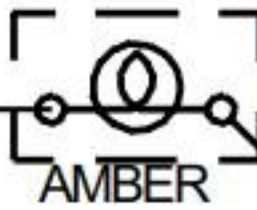

HEATING ELEMENT



208 OR 240V

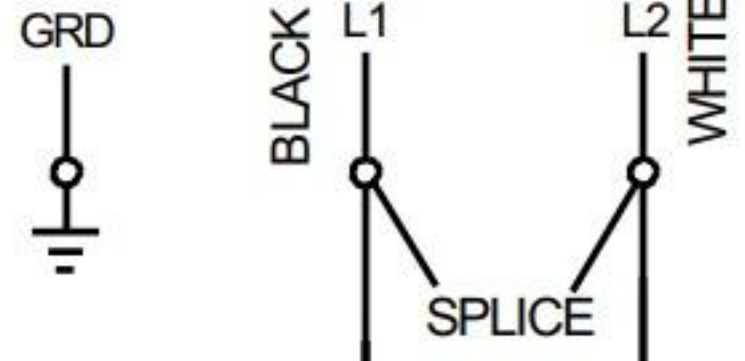

THERMOSTAT

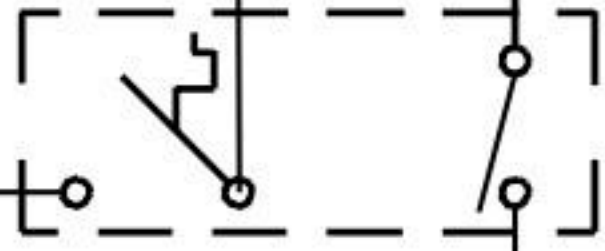

HI-LIMIT SWITCH

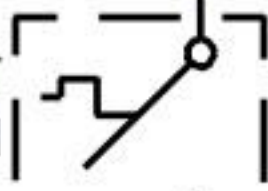

PILOT LIGHT

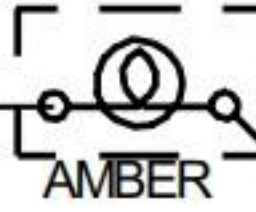

HEATING ELEMENT





