

OWNERS & OPERATORS INSTRUCTION MANUAL

Model # _____

Serial # _____

Model 500LR

FOR GLOBE SLICER MODELS 500LR, 725LR, 775LR, 825LR, 850LR & 875LR

For service contact:

(place service sticker here)

Globe Food Equipment
1-513-299-5493

WARNING→

This manual contains important safety instructions which must be strictly followed when using this equipment.

WARNING→

Read this manual completely prior to using or cleaning the Slicer.

INDEX

KEY COMPONENTS	4
CAUTION CARD.....	5
INSTALLATION	6
OPERATING INSTRUCTIONS	7
AUTOMATIC INSTRUCTIONS.....	8
CLEANING.....	10
KNIFE SHARPENING	14
LUBRICATION	16
SIMPLE MAINTENANCE AND REPAIR.....	18
OPTIONAL ACCESSORIES	19
OPTIMAL SLICER USE	22
TROUBLESHOOTING	23



GLOBE FOOD EQUIPMENT CO.
3033 KETTERING BLVD.
DAYTON, OHIO 45439
PHONE: 513/299-5493
FAX: 513/299-4147

This publication has been prepared by Globe Food Equipment Company for use by its employees and assigned representatives. Any reproduction of this publication or material contained within is strictly prohibited without the express written consent of the Globe Food Equipment Company.
© Globe Food Equipment Company, 1992.

PRECISION SLICERS SINCE 1919

KEY COMPONENTS OF THE SLICER

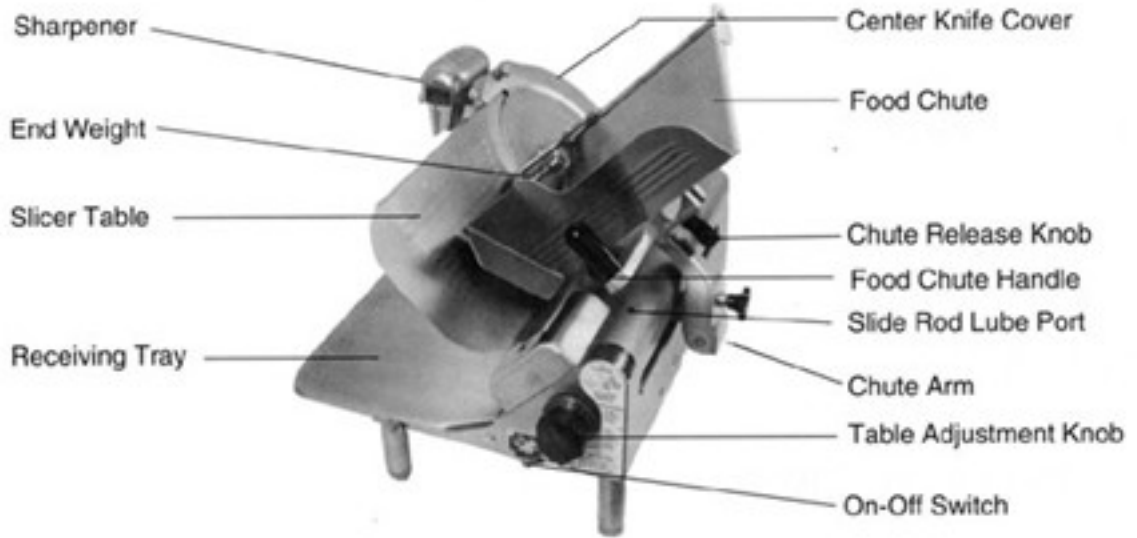

500LR FRONT VIEW



500LR SIDE VIEW

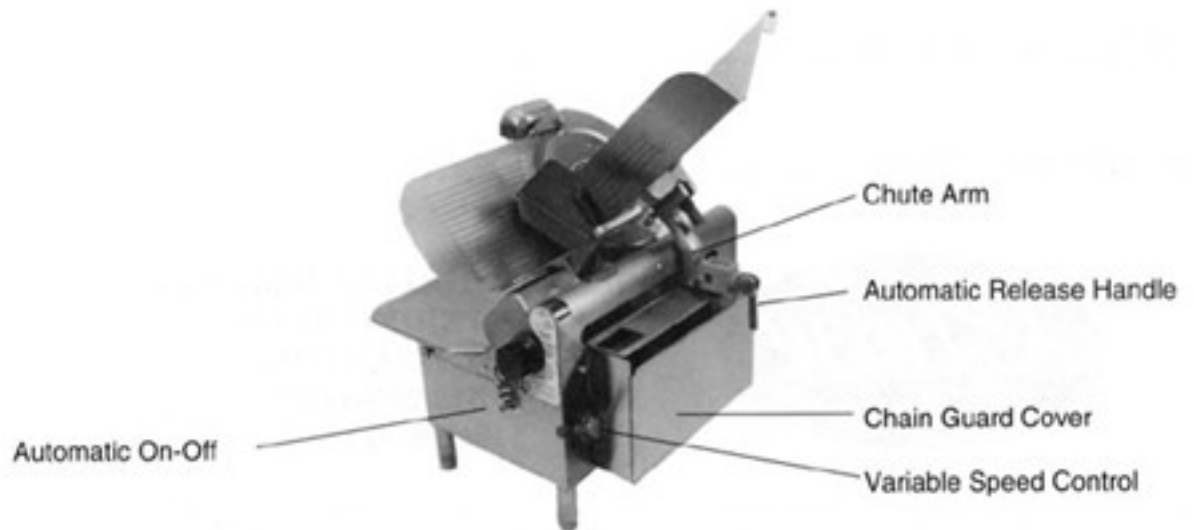

MODEL 775LR AUTOMATIC

WARNINGS
GLOBE CAUTION CARD

*** READ THESE INSTRUCTIONS PRIOR TO USING SLICER ***

- 1 - FEDERAL LAW PROHIBITS anyone under 18 years of age from using or cleaning meat slicers.
- 2 - BEFORE CLEANING OR REMOVING ANY PARTS, always turn off all switches and unplug slicer.
- 3 - NEVER TOUCH KNIFE EDGE - IT WILL CUT YOUR FINGERS. Keep hands away from exposed knife and replace knifeguard as soon as possible.
- 4 - NEVER OPERATE OR CLEAN A SLICING MACHINE unless you are properly trained and fully qualified by your Supervisor.
- 5 - BEFORE OPERATION, knifeguard must be securely installed and knife fully shielded.
- 6 - BEFORE SLICING, check Food Chute. It must be securely installed. A loose Food Chute will damage knife.
- 7 - CLOSE SLICE DEFLECTOR whenever slicer is in operation.
- 8 - USE CHUTE HANDLE when pushing Food Chute on Semi-Automatic.
- 9 - DON'T CATCH SLICES WITH YOUR HAND. Let slices drop on paper covered receiving tray.
- 10 - USE THE ENDWEIGHT, NOT YOUR HAND, to hold products when slicing. Never put your hand on or around Food Chute when slicer is on.
- 11 - SLICER MUST BE ELECTRONICALLY GROUNDED and operated from proper power source.
- 12 - BEFORE CLEANING SLICER TABLE AND KNIFE, turn slice thickness dial clockwise to closed position.
- 13 - ALWAYS CLEAN KNIFE BEFORE SHARPENING. A dirty knife will fill sharpening stones with food, making them ineffective.
- 14 - ALWAYS CLEAN AND SANITIZE SLICER after sharpening or when switching from mild foods (cheese) to highly seasoned foods (salami, etc.).
- 15 - USE ONLY GLOBE SLICER ACCESSORIES properly installed.

THIS CAUTION CARD WAS ENCLOSED WITH YOUR SLICER. IF YOU DID NOT RECEIVE ONE OR WOULD LIKE ADDITIONAL COPIES, PLEASE CONTACT GLOBE.

INSTALLATION

UNPACKING:

Unpack the slicer immediately after receipt. If the machine is found to be damaged, save the packaging material and contact the carrier within fifteen (15) days of delivery. Immediately contact your source of the equipment.

You should receive with the slicer a caution card, legs, rubber feet, Globe oil, operation and care manual and wall chart. Contact Globe or your machine source if you did not receive all of these materials.

WARNING→

Use at least two people to lift slicer up to operating location. Never attempt to lift slicer alone.

1. Remove the corrugated box from the skid by extracting fastener nails at the bottom of the box.
2. Carefully unbolt slicer from bottom of skid.
3. Attach rubber feet to legs, then legs into slicer base.

WARNING→

Never use slicer without rubber feet installed.

WARNING→

Machine must be installed and operated on solid, level support.

ELECTRICAL WARNING

This machine is provided with a three prong grounding plug. If the outlet you are using is not properly grounded, contact an electrician.

4. Complete warranty card and mail to Globe factory.
5. Clean the slicer using the procedures outlined in the cleaning section prior to using the slicer.

OPERATING INSTRUCTIONS

WARNING→

Read this entire section carefully prior to using the slicer. The knife is extremely sharp and can cause serious injury.

MANUAL SLICER OPERATION:

1. With slicer off, pull the chute completely toward you and place the product on the chute. Slice only boneless, unfrozen product with the slicer. Use the end weight to hold the product in place. If the end weight is not needed, it may be stored out of the way by swinging it back behind the chute and locking it on the retaining nut.

WARNING→

Do not hold the food product with your hand. Never put your hand on or around food chute when slicer is on. The chute handle is the only part of the slicer you should touch while slicing.

WARNING→

Do not load or unload food product while slicer is on. Always turn off slicer, close slicer table and pull chute completely toward you before you put your hands in the chute.

2. Make sure all knobs are tightened prior to using the slicer.
3. Rotate the thickness adjustment knob counterclockwise to desired slice thickness. After slicing is complete, always turn thickness knob completely clockwise to close table.
4. Turn slicer on.
5. Use the chute handle to manually push the chute back and forth. The chute handle is the only part of the slicer you should touch while slicing. Do not catch slices with your hand. Let slices drop on a paper covered receiving tray.
6. Turn off slicer after each use.
7. Pull chute completely toward you, close slicer table and remove product from the chute.

WARNING→

After slicing is complete always turn thickness knob completely clockwise to close the table.

WARNING→

If the product needs to be adjusted during slicing, always turn off slicer, close slicer table and pull chute all the way toward you prior to adjusting the product and the end weight.

MANUAL USE OF AUTOMATIC SLICER

Automatic slicers can be used manually when desired. When manually operating an automatic slicer, turn on only the knife motor (top switch). The bottom switch controls the chute motor and should not be turned on. The release handle must be in the lower position to manually move the chute. (See Fig. 9-4.)

The knife motor is controlled by the top switch.

AUTOMATIC SLICER OPERATION

WARNING→

Do not operate automatic slicer without chain guard in place covering the chain and sprockets. Keep hands away from chain and sprockets at all times.

1. Make sure all switches are in the OFF position. The release handle should be in the lower position and the chute should move freely.
2. Pull the food chute completely toward you and load the product. Swing end weight into position to secure product.
3. Insure speed selector knob or lever is at zero (0).
 - a. Lever (Model 775LR) should be lifted all the way up to zero (0). (Fig. 8-1)
 - b. Dial (Models 850LR, 875LR) should be turned completely counterclockwise to zero (0). (Fig. 8-2)



Fig. 8-1

 **NOTE:** Models 725LR and 825LR slicers are single speed and do not have chute speed controls.

4. If product is too long, place endweight on top of the product and use the endweight prongs to hold the product in place.
5. Engage slicer into automatic mode by lifting release handle upward into locking position. Locking into position may require a slight force or tapping with your palm to secure. (Fig. 8-3)
6. Turn knife motor on.



Fig. 8-2



Fig. 8-3

WARNING→

The next steps will cause food chute to move automatically.

7. Turn chute motor on.
8. To activate automatic chute, lower speed lever or turn dial clockwise to increase chute speed to desired setting. (See Fig. 8-1 & Fig. 8-2)



NOTE: Slow speeds should be used when slicing soft or delicate products. Processed or firm products can be sliced at higher speeds.

AUTOMATIC SLICER OPERATION

WARNING→

Never attempt to load or unload chute when slicer is on or in automatic position.

9. After slicing the desired amount of product, first turn off the chute motor switch, then switch off the knife motor.
10. Remove slicer from automatic mode, by pulling down release handle to lower position. (Fig. 9-4) (The chute should be free to move manually forward and backward.) Turn the table adjustment knob all the way clockwise to close the table. Pull the chute handle all the way toward operator. Now you can load or unload the food product.



Fig. 9-4

WARNING→

If slicer release handle remains in up position, the slicer chute will be engaged and automatically move when the chute motor is turned on.

AUTOMATIC SPEED SETTINGS

<u>MODEL #</u>	<u>STROKES PER MINUTE</u>	<u>CONSTANT/VARIABLE</u>
725LR	40	CONSTANT
825LR	40	CONSTANT
775LR	1-55	VARIABLE
850LR	1-60	VARIABLE
875LR	1-60	VARIABLE

CLEANING

Your slicer should be cleaned and sanitized as often as necessary or at least once per day. Slicer components are easily disassembled without the use of special tools.

Before cleaning , always follow these procedures:

WARNING→

Turn the motor switch(es) OFF. Unplug the power cord. Be sure switches are in "OFF" position.

WARNING→

Turn the slice adjustment knob fully clockwise so table covers knife edge.

WARNING→

The slicer knife is sharp. Exercise extreme caution when working near the knife.

It may be desirable to wear non-cutting safety gloves during the cleaning operation.

A. Disassembly

To begin the cleaning procedure, disassemble the following components:

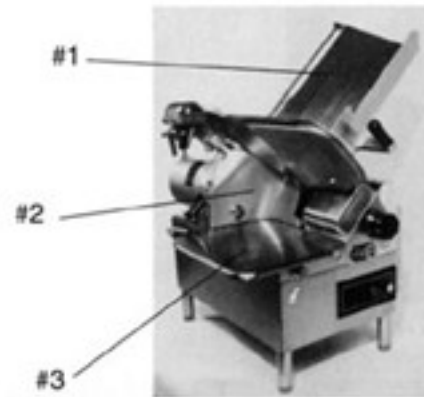

1. **FOOD CHUTE:** Remove the food chute (#1) by loosening the chute knob that fastens the chute to the support arm. Lift the chute off the support arm.
2. **HINGED SLICE DEFLECTOR:** The hinged slice deflector (#2) opens and closes like a door. To remove the deflector, open completely outward and lift up and away.
3. **RECEIVING TRAY:** The receiving tray (#3) is held securely in position by means of knurled nut located under the front of the receiving tray. The hinged slice deflector (#2) must be removed prior to removing the receiving tray. After the deflector has been removed, remove the tray by loosening the knurled nut to free receiving tray. Lift tray up and away.
4. **WASTE RECEIVER (Juice Box):** The hinged slice deflector must be removed before the waste receiver can be removed. After removing the deflector, remove the waste receiver for emptying and cleaning by pulling the receiver toward the front of the slicer until it is free.

CLEANING

5. **CENTER KNIFE GUARD:** The knife guard is removed by completely loosening the release knob. (Fig. 11-4) While holding the knobs on the top of the guard, lift upward to remove. (Fig. 11-5)

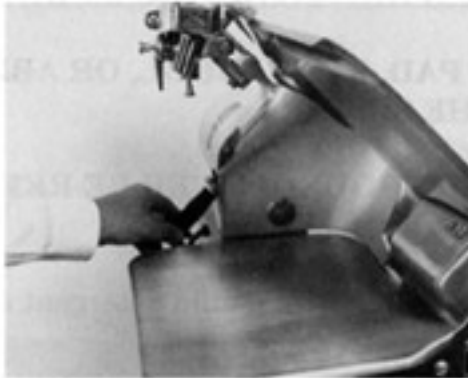

Fig. 11-4



Fig. 11-5

WARNING→

NEVER ATTEMPT TO REMOVE OR DISMANTLE THE KNIFE RING GUARD.

WARNING→

NEVER TRY TO REMOVE THE KNIFE FROM THE SLICER. IT MUST REMAIN ON THE SLICER FOR PROPER SHARPENING AND CLEANING.

6. **CHAIN GUARD COVER (Automatic Models Only):** Remove the chain guard cover (Fig. 11-6) by loosening the screws. Do not allow the chain guard cover to fall. Push in on the sides of the chain guard cover to remove from the screws.

Chain guard retention screw

Chain guard cover

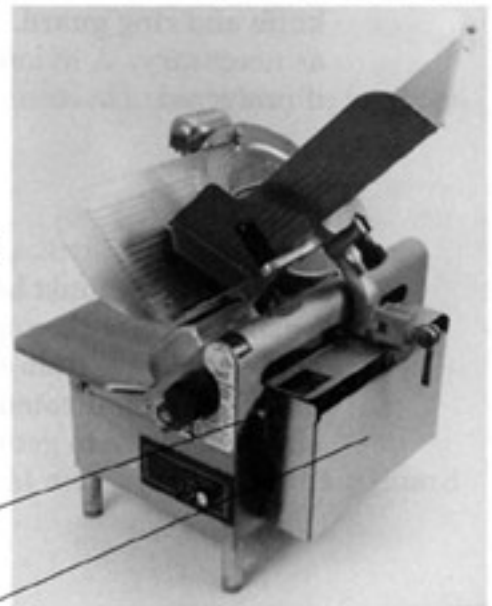



Fig. 11-6

WARNING→

Do not operate slicer with out chain guard cover in place. Keep hands away from chain and sprockets at all times.

CLEANING

-  **NOTE: 1. DO NOT PUT COMPONENTS IN DISHWASHER.**
- 2. DILUTE DETERGENT PER SUPPLIER'S INSTRUCTION.**
 - 3. NO PARTS OF THE SLICER ARE TO BE PRESSURE WASHED.**
 - 4. NEVER USE SCRUBBER PAD, STEEL WOOL, OR ABRASIVE MATERIAL TO CLEAN THE SLICER.**
 - 5. THE SLICER SHARPENER SHOULD NEVER BE REMOVED FROM THE SLICER OR IMMERSSED IN WATER.**
 6. Clean the disassembled components with a mild detergent and warm water solution. Allow parts to air dry.

7. The knife ring guard must now be cleaned. To clean the knife ring guard, soak a clean cloth in the mild detergent and warm water solution. **Carefully** insert the cloth between the knife and the ring guard as indicated by Figure 12-7. While holding the cloth between the knife and the ring guard, work it along the entire back side of the knife, between the knife and ring guard. Repeat this procedure as necessary. A nylon brush could also be used if preferred.



Fig. 12-7

8. The knife also must be cleaned. **Carefully** wash and rinse the top and bottom of the knife by wiping from the **center of the knife outward** as indicated by Figure 12-8. Do not allow moisture to get into knife hub.



Fig. 12-8

9. Now replace the center knife guard. Hold the center knife guard with one hand while securely tightening the release knob with the other hand. Be sure the center knife guard is rotated completely counter-clockwise.

CLEANING

10. With the table completely closed, wipe the slicer table off by starting at the knife and pulling toward you. **Never wipe the table toward the knife.**
11. Clean and wipe down the entire slicer. Use a mild sanitizer if required. Do not use a caustic or strong detergent on the slicer base or components.

B. Reassembly

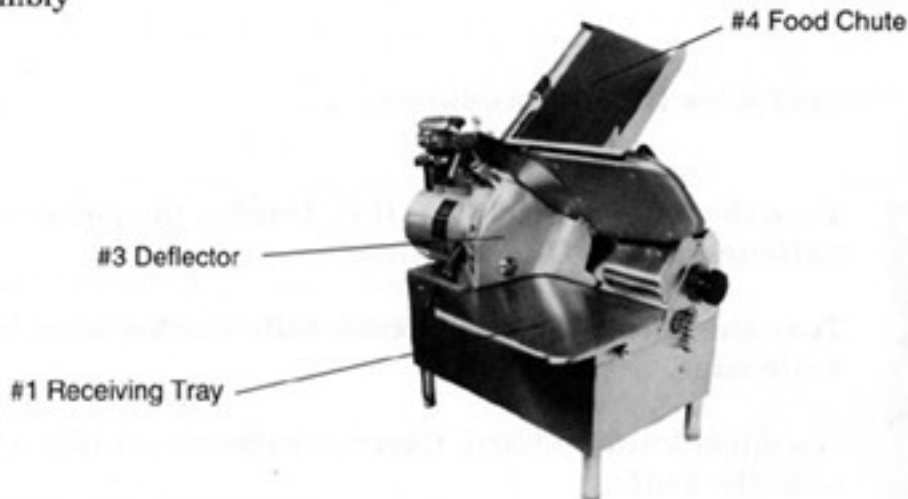

1. Replace the waste receiver (juice box) by sliding it over the retaining guide pin and pushing toward the rear of the slicer.
2. Replace receiving tray (#1) to original position. Tighten knurled knob to secure in place.
3. Replace hinged slice deflector (#3) and snap closed.
4. Install food chute (#4) to the original position on the chute arm. Tighten chute knob securely to prevent any "play" between the food chute and chute arm.

ON AUTOMATIC ONLY:

5. Replace chain guard cover to original position. Align front and back slot of chain guard cover with screws. Tighten front and back screws.

WARNING→

Do not operate automatic slicer without chain guard cover securely in position. Keep hands away from chains and sprockets at all times.

 **NOTE:** The slicer will not operate unless the center knife guard is in place and tightened down using the release knob.

KNIFE SHARPENING

1. Symptoms of a dull blade are excess waste/or a “tail” on the unsliced portion remaining in the meat chute.
2. The Globe knife needs to be sharpened periodically to provide consistent slices and maximum product yield. Sharpening the knife lightly every few days is more efficient than heavy sharpening at less frequent intervals.

Before sharpening, always follow these procedures:

WARNING→

Turn the motor switch(es) OFF. Unplug the power cord. Be sure switches are in “OFF” position.

Turn the slice adjustment knob fully clockwise so table covers knife edge.

The slicer knife is sharp. Exercise extreme caution when working near the knife.

A. Preparing to Sharpen

1. Clean and dry both sides of the knife before sharpening. (Refer to Page 12 for knife cleaning procedures.) Expose sharpening stones by lifting the knife sharpener cover (Fig. 14-1). The stones should be clean and dry.



Fig. 14-1

2. To expose the knife edge for sharpening, loosen the release knob (#1) and rotate the center knife cover (#2) clockwise. Re-tighten the release knob. Using the knob located on the ring guard (#3), (Fig. 14-2) carefully lift the hinged portion of the ring guard away from the knife.

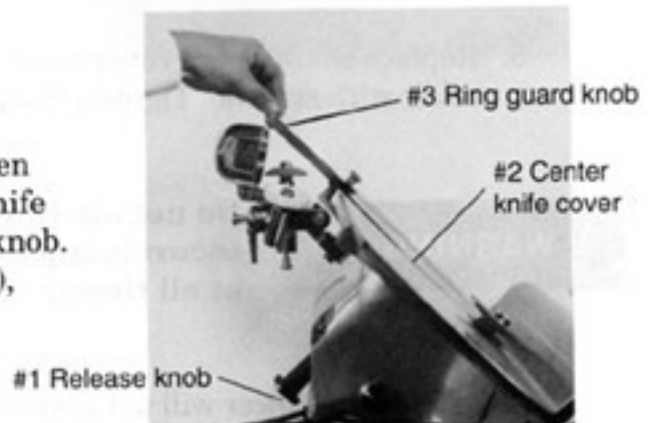



Fig. 14-2

KNIFE SHARPENING

To sharpen the knife, proceed as follows:

1. Pull out Knob #1 (Fig. 15-1) and swing sharpener into position for use.
2. Plug in machine power cord. Turn on knife motor. (Top switch on automatic slicers.)
3. Turn the handle counterclockwise (Fig. 15-2 #1) to bring stones into contact with the knife. Maintain pressure on the handle until knife has a sharp edge (approximately 15-30 seconds). Be sure both stones are in good contact with knife only.

 **NOTE:** If knife becomes very dull, activate only the bottom stone by pushing in Knob #2. (Fig. 15-2)

When sharpening with the bottom stone is completed, pull out Knob #2. This allows simultaneous sharpening with both stones. Always finish sharpening using both stones.

4. With slicer turned off and unplugged, inspect the back of the knife to determine if additional sharpening is necessary. If black lines are evident on the knife, sharpening is finished. If black lines are not evident, repeat the sharpening procedure.

B. Finishing Sharpening

When sharpening is finished, follow these procedures:

1. Turn the motor switch OFF. Unplug the power cord. Be sure all switches are in "OFF" position.
2. Return the sharpener to its original position by pulling out knob and swinging back.
3. Carefully close the hinged area of the ring guard using the knob located at its top.
4. Loosen release knob and rotate top knife cover counterclockwise to its original position. Tighten release knob.
5. Wipe sharpening stones clean.
6. Close sharpener cover.
7. Clean slicer as necessary using cleaning procedures listed on pages 10 thru 13.

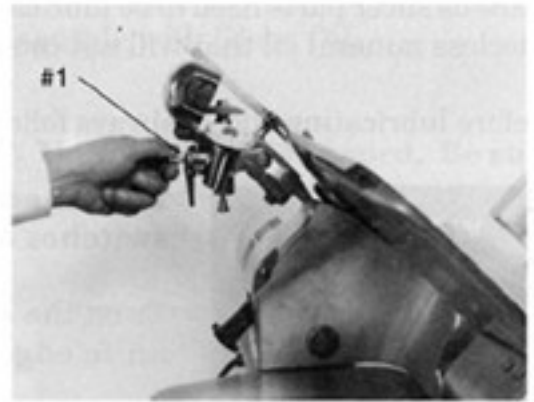

Fig. 15-1



Fig. 15-2

LUBRICATION

Various slicer parts need to be lubricated periodically using Globe Oil. Globe Oil is a light, tasteless, odorless mineral oil that will not contaminate or impart odors or taste to sliced product.

Before lubricating slicer, always follow these procedures:

WARNING→

Turn the motor switch(es) OFF. Unplug the power cord. Be sure switches are in "OFF" position.

Turn the slice adjustment knob fully clockwise so table covers knife edge.

The slicer knife is sharp. Exercise extreme caution when working near the knife.

Do not use vegetable oil to lubricate slicer. Vegetable oil will damage the slicer.

A. Chute Slide Rods

It is necessary to lubricate the chute slide rods with Globe Oil weekly or when excessive drag is felt.

1. To do so, pull food chute handle completely forward (toward operator). (Fig. 16-3) Remove the chute to improve the access to the oil hole.
2. Pull out cap to open can. Add several drops of Globe Oil into the slide rod hole.
3. Wipe off excess oil.

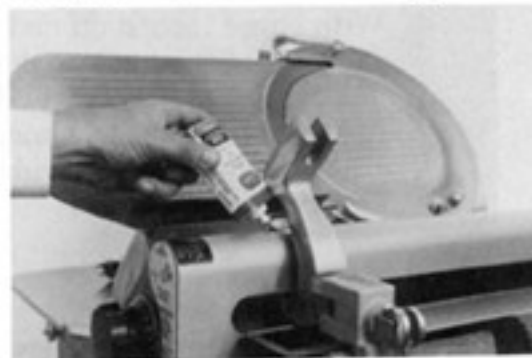

Fig. 16-3

B. End Weight Slide Rod

1. The end weight slide rod (Fig. 16-4 #1) should be lubricated weekly with a few drops of a tasteless, food-safe oil. The Globe Oil is intended for this use.

#1 End Weight Slide Rod



Fig. 16-4

LUBRICATION

C. Automatic Slicer Chains

The chains on automatic slicer models should be lubricated monthly with Globe Oil.

WARNING→

Turn the motor switch(es) OFF. Unplug the power cord. Be sure switches are in "OFF" position.

1. Remove the chain guard cover as explained on page 11.
2. Pull out cap to open Globe Oil can. Apply oil to each chain link. Wipe off excess oil. (Fig. 17-1)
3. Reassemble chain guard cover immediately as explained on page #13. Do not operate slicer without chain guard cover in position. Keep hands away from sprockets at all times.



Fig. 17-1

D. Sharpener

WARNING→

Turn the motor switch(es) OFF. Unplug the power cord. Be sure switches are in "OFF" position.

1. The sharpener shafts should be lubricated once per month with a few drops of oil.
2. Add oil to each of the sharpener shaft holes where the shaft enters the sharpener housing. Lift stone completely upward to expose hole.

OTHER LUBRICATION

It is recommended that all threaded screws be lubricated after each cleaning to maximize the life of your slicer.

A. Plastic Knife Scraper Replacement

The plastic knife scraper is standard on all slicer models. The knife scraper prevents product from building up on the knife surface. To replace the knife scraper, follow the outlined procedures:

WARNING→

Turn the motor switch(es) OFF. Unplug the power cord. Be sure all switches are in "OFF" position.

1. Remove the center knife guard (Fig. 18-1) by completely loosening the release knob and lifting out holding the knobs on the cover (#1). The ring guard is not removable. Do not attempt to remove knife ring guard.
2. Unloosen the knurled thumb screw (#2) and remove knife scraper assembly (designated in Fig. 18-1).
3. Replace with new plastic scraper. (Replacement parts can be obtained from your Globe Distributor.)
4. Replace the center knife guard. Hold the center knife guard in place with one hand while securely tightening the release knob with the other hand. Be sure the knife guard is rotated completely counter-clockwise.
5. Be sure the extreme tip of the plastic scraper touches the inside edge of the knife.

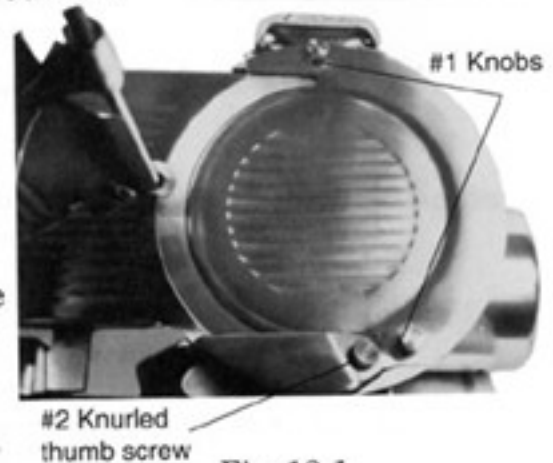

Fig. 18-1

B. Signal Lamp Replacement

All Globe slicers are equipped with a signal lamp that lights up whenever the knife motor is turned on. Signal lamps may need to be replaced periodically. To replace the signal lamp, follow the outlined procedures:

WARNING→

Turn the motor switch(es) OFF. Unplug the power cord. Be sure switches are in "OFF" position.

1. Open hinged slice deflector. The signal lamp is located on the slice deflector.
2. Remove the lens from the retaining socket.
3. Remove the bulb by twisting counter-clockwise with a slight inward pressure.
4. Replace with a new bulb.
5. Replace plastic lens.
6. Close hinged slice deflector.

A. Tubular Chute

The tubular chute (Fig. 19-1) temporarily converts your slicer into an efficient, heavy-duty meat, fruit, and vegetable slicer. To use the tubular chute, follow the outlined procedures.



Fig. 19-1

WARNING→

Turn the motor switch(es) OFF. Unplug the power cord. Be sure switches are in "OFF" position.

1. Remove the tubular chute by loosening chute knob that fastens chute to support arm. Lift the chute off the support arm.
2. Remove end weight from tubular chute. Place the tubular chute in position on the support arm. Tighten chute knob securely to prevent any "play" between the chute and carriage.
3. Fill the hopper with desired product. Place end weight in chute.
4. Select desired setting with slice thickness adjustment control.
5. Turn slicer on. Begin manual or automatic slicing. Follow operating instructions on page 7.
6. Clean the tubular chute and end weight with a mild detergent and a warm water solution.

WARNING→

DO NOT PUT HANDS INSIDE TUBULAR CHUTE DURING SLICER OPERATION. DO NOT USE END WEIGHT TO PUSH CHUTE.

B. Slicer Fences

Slicer fences (Fig. 20-1) provide extra support to food items during slicing. Two types are available: a regular fence for slicing tomatoes, onions, fruits, cheese, meats, etc.; and a tapered fence. To use the slicer fences, follow the outlined procedures:

WARNING→

Turn the motor switch(es) OFF. Unplug the power cord. Be sure all switches are in "OFF" position.

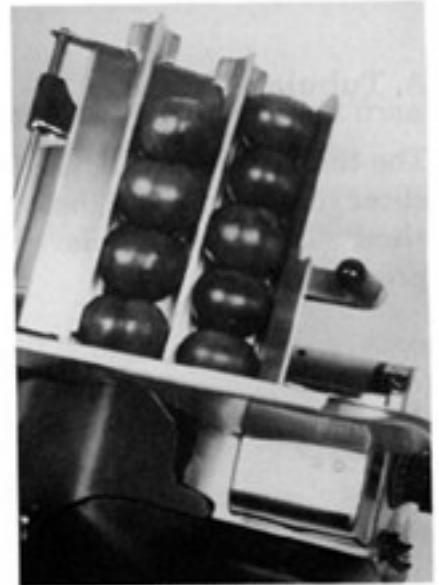

Figure 20-1

1. Be sure food chute end weight is in stored position behind food chute.
2. Place fence in desired position on the slicer food chute.
3. Tighten fence thumb screw to secure fence to chute.
4. Two or more fences may be used for quantity slicing.
5. Load product.
6. Select desired setting with slice thickness adjustment control.
7. Turn slicer on. Begin manual or automatic slicing. Follow operating instructions located on page 7.
8. Clean the slicer fences with a mild detergent and warm water solution.

C. Bagel/Onion/Tomato Chute

The bagel chute (Fig. 20-2) accessory can be used in place of the food chute to convert "day old bagels" into thin, resellable chips. To use the bagel chute, follow the outlined procedures:



Figure 20-2

OPTIONAL ACCESSORIES

WARNING→

Turn the motor switch(es) OFF. Unplug the power cord. Be sure switches are in "OFF" position.

1. Remove the food chute by loosening the chute knob that fastens chute to support arm. Lift the chute off the support arm.
2. Place the bagel chute in position on support arm. Tighten chute knob securely to prevent any "play" between the bagel chute and support arm.
3. Fill the chute with desired product. Place end weights in position.
4. Select desired setting with slice thickness adjustment control.
5. Turn slicer on to begin manual or automatic slicing. Follow operating instruction located on page 7.
6. Clean the bagel chute with a mild detergent and warm water solution.

D. Juice Box

The juice box (Fig. 22-1) provides a neat, sanitary method of retaining the valuable meat juices lost when slicing hot meats while keeping sliced product clean. The juice box is removed easily for cleaning. To clean the juice box, follow the outlined procedures:

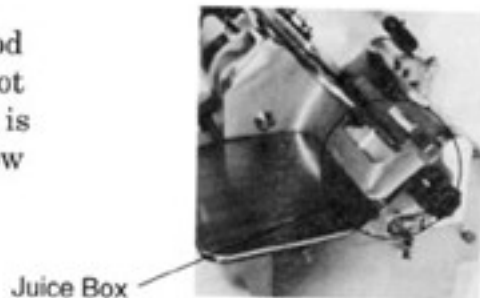

Figure 22-1

WARNING→

Turn the motor switch(es) OFF. Unplug the power cord. Be sure switches are in "OFF" position.

1. The juice box is placed on front of table and held in position by means of a hinge clip.
2. Clean the juice box with a mild detergent and warm water solution.

TO OBTAIN THE MAXIMUM PERFORMANCE AND YIELD FROM YOUR GLOBE SLICER FOLLOW:

THE OPTIMAL SLICER USE

1. Lubricate the slicer per the instructions on page 16.
2. Maintain a sharp blade and replace as necessary. Never attempt to replace the blade yourself.
3. Keep sharpening stones dry and clean.
4. Clean blade prior to sharpening slicer.
5. As the blade is sharpened and the diameter gets smaller, it is important to:
 - a. Adjust thickness table inward toward knife. Gap should be consistently 1/8" from knife.
 - b. Move sharpener downward to maintain proper contact with blade.

We recommend an authorized Globe service company or distributor to perform all adjustments and major maintenance.

By adequately maintaining your slicer, it will provide years of dependable service. The only way to damage a Globe slicer is by neglect.

TROUBLESHOOTING GUIDE

<u>TROUBLE</u>	<u>CAUSE</u>	<u>CORRECTION</u>
Slicer does not turn on	Check power cord Check breaker Switch off Top knife cover not in proper position with release knob tightened Motor overload	Plug in slicer Re-set breaker Turn switch on Top knife cover in place and release knob tightened Press reset button on models 725LR and 825LR
Ragged cuts-poor yield	Dull knife Chipped blade Table gap	Sharpen knife Sharpen or replace blade Call for service to adjust table
Metal rubbing knife	Top knife guard Chute End Weight Table	Tighten knife cover release knob Tighten chute stud knob Replace bent or broken end weight Call for service to adjust or tighten table
Automatic chute doesn't travel	Switch off Release handle in down position	Turn switch on Place release handle in up position
Hard to push chute	No lubrication	Lubricate slide rods thoroughly
Hard to sharpen	Stones dirty or wet Knife dirty Worn stones Stones not properly aligned	Clean stones with ammonia Dry stones Clean top and bottom of knife Replace stones Adjust stones