

PARTS MANUAL

MVP & MVP Hydra

Version 2021.1

Last Revision: July 2021



5610 4th Ave S. / Seattle, WA 98108—USA

Tel: +1 206 764 0600 / Fax: +1 206 764 0601

Ordering Parts: parts@synesso.com

Information: info@synesso.com

www.synesso.com

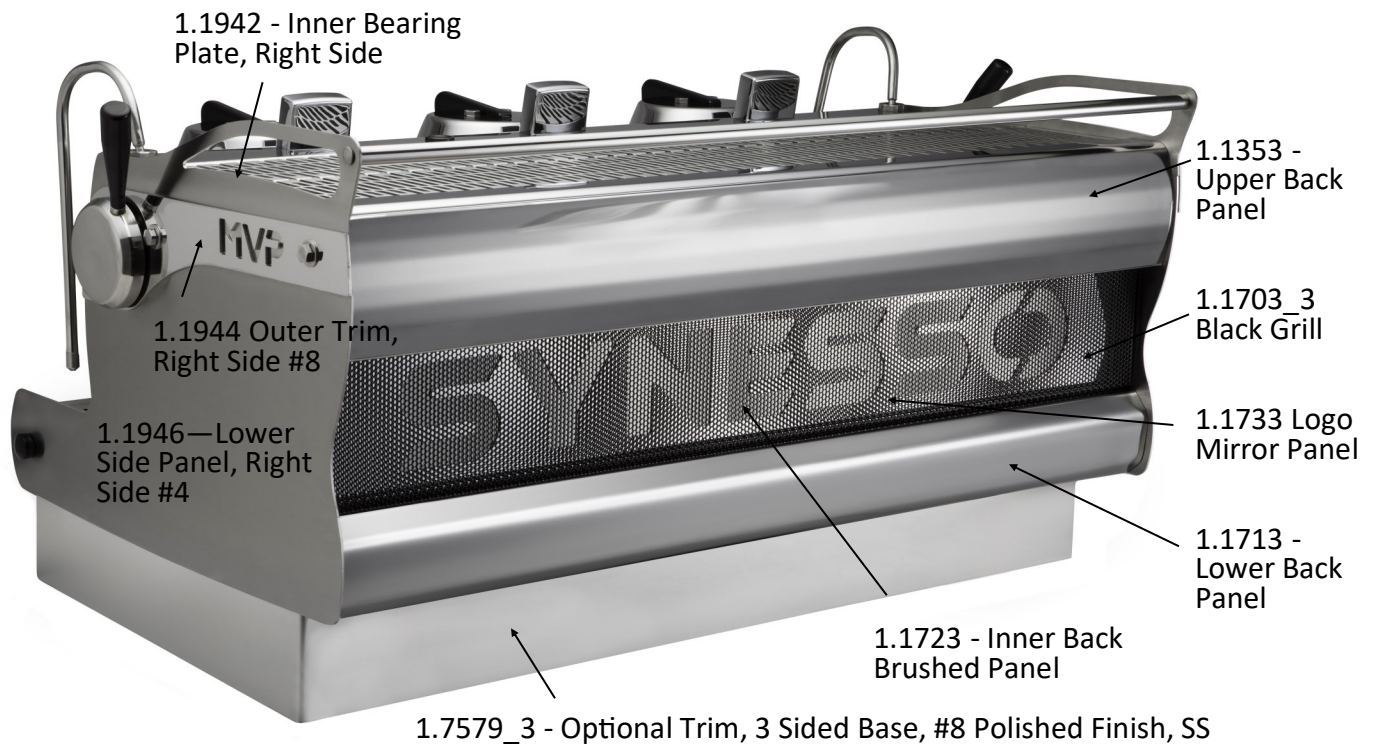
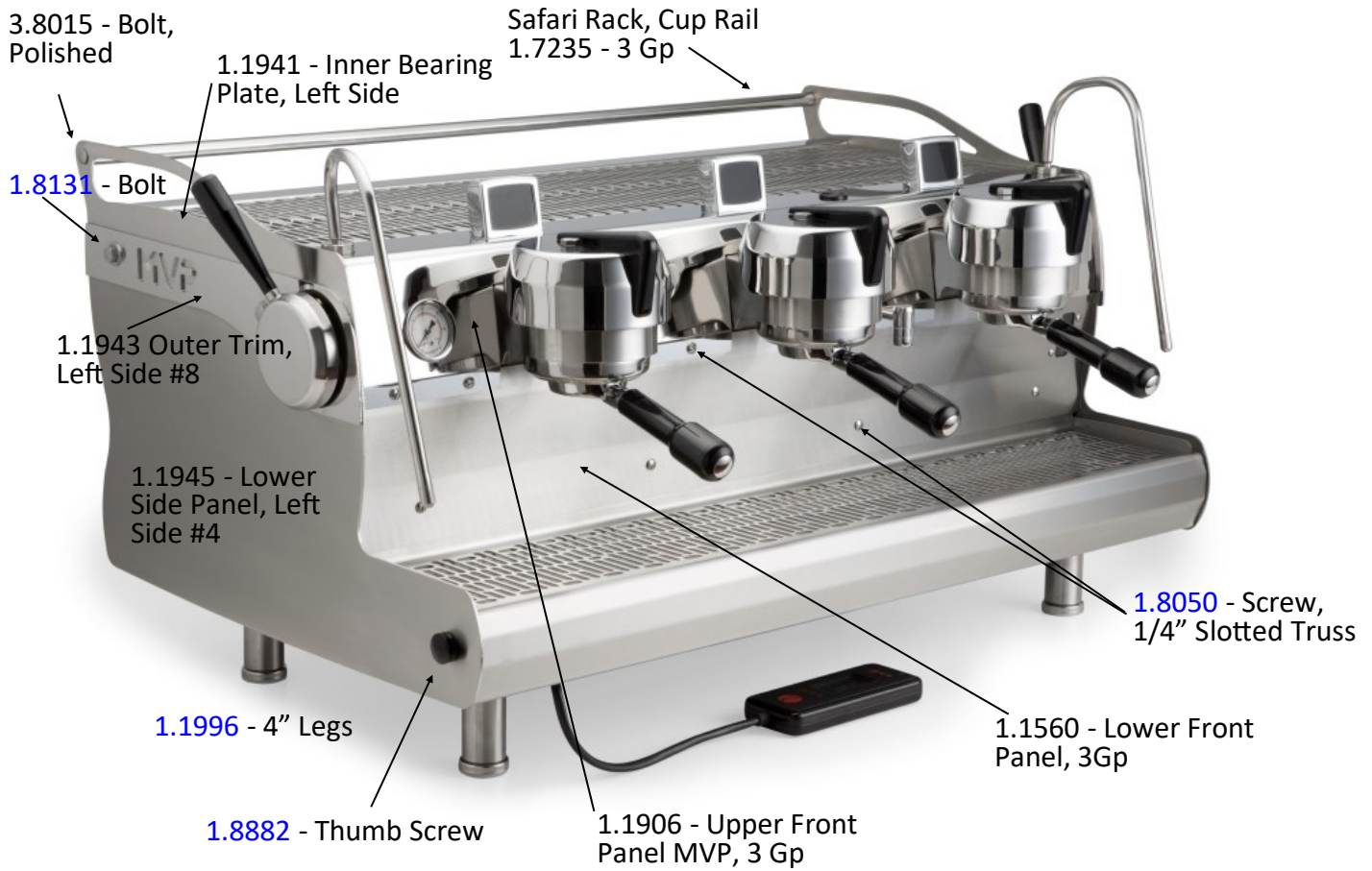

Table of Contents

Section	Pages
Body Panels	3-4
Side Panel Drawings	5-6
Body Accessories and Components	7
Body Hardware and Components	8
Pressure Gauges	9
Body Part Numbers & Descriptions	9-11
Group Top Assembly	12
Group Top Actuator Assembly	13
Group Top Part Numbers and Descriptions	13
Major Components, Water Inlet, Right Side	14
Tubes for 1Gp MVP Hydra / Tubes to Water Tap and Gauges	15
Hot Water Assemblies and Fittings / Sight Glass	16
Steam Assembly	17
Brew Inlet and Flow Meter Configurations for MVP	18
Brew Inlet and Flow Meter Configurations for 2 & 3 Gp, MVP Hydra	19
Brew Inlet and Flow Meter Configurations for 1 Gp, MVP Hydra	20
Major Components, Water Outlet, Left Side	21
Universal Steam Tank Assembly	22-23
Universal Brew Tank Assembly	24-25
Drain Tube and Manifold Assemblies	26
Electrical Components	27-29
Pressure Regulators and Manifolds	30
Bypass Assemblies	31
Pump and Motors / Line Boost System	32
Portafilters and Baskets	33
Parts and Kits	34-35
Wood Kits	36
Wood Kits, Parts and Descriptions	37
Options and Accessories	38

Body Panels

***Shown: MVP, 3 Group, with #8 Mirror Polished Accents**



Body Panels Continued

*Shown: MVP Hydra, 1 Group. **Black Nickel Plated Accents No Longer Available

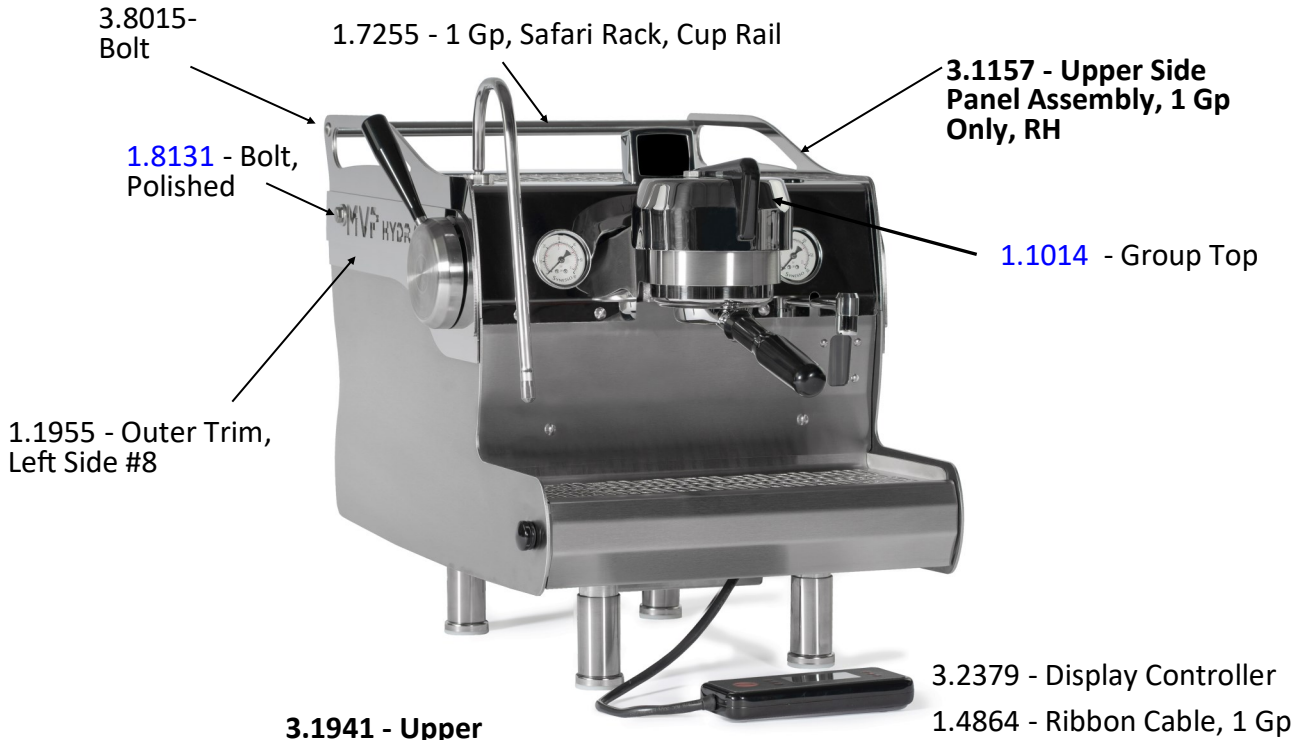

1.1782 - Synesso Logo, 4" Diameter, Cast & Polished. Comes on the back panel of 1 Gp MVP Hydras

1.1782 - Synesso "S" Logo, 4" Cast & Polished

MVP Series Fasteners Polished Stainless Steel



1.8440
Side Panel Washer



1.8131 3.8020 3.8015
Side Panel Group Top Safari Rack

Body - Side Panels

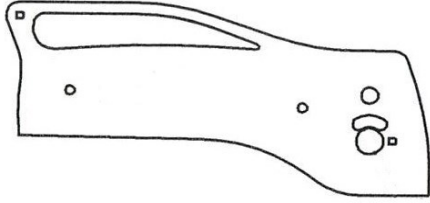

MVP Hydra

Top Outer Panel

#8 Mirror Finish

Left Side - 1.1951

Right Side - 1.1952

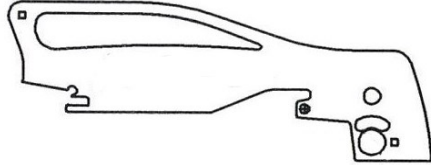
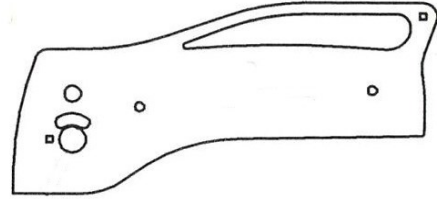

MVP Hydra

Inner Bearing Plate

#8 Mirror Finish

Left Side - 1.1953

Right Side - 1.1954

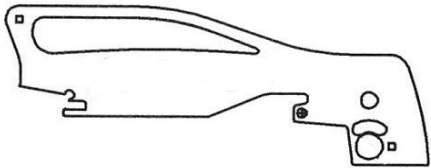
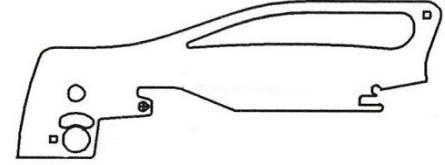

MVP

Inner Bearing Plate

#4 Brushed Stainless

Left Side - 1.1941

Right Side - 1.1942

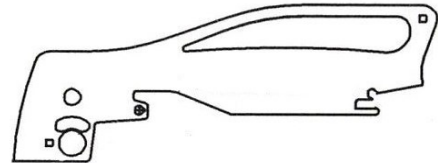

MVP Hydra

Outer Trim Plate

#8 Mirror Finish

Left Side - 1.1955

Right Side - 1.1956



MVP

Outer Trim Plate

#8 Mirror Finish

Left Side - 1.1943

Right Side - 1.1944



MVP Hydra

Outer Trim Plate - 1 Gp

#8 Mirror Finish

Right Side - 1.1958

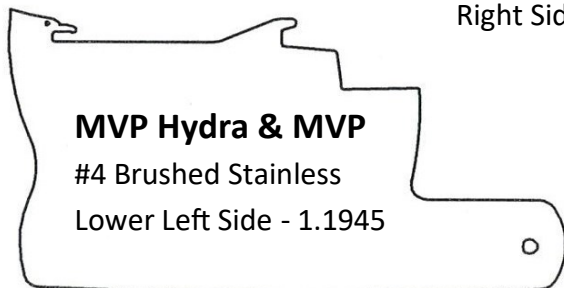

MVP Hydra & MVP

#4 Brushed Stainless

Lower Left Side - 1.1945

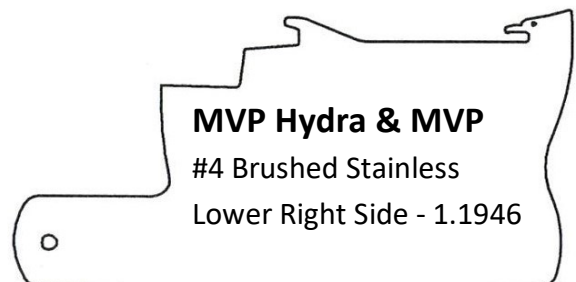

MVP Hydra & MVP

#4 Brushed Stainless

Lower Right Side - 1.1946

Body - Side Panels



Upper Top 2 Panels for MVP, Right Side
 1.1942 - Inner Bearing Plate, #4 Brushed Stainless
 1.1944 - Trim Plate, MVP, #8 Polished Stainless

Inner bearing Plate, Resides behind 1.1952



Upper Top 3 Panels for MVP Hydra, Right Side
 1.1952 - Top Outer Plate, #8 Polished Stainless
 1.1954 - Inner Bearing Plate, #8 Mirror Finish
 1.1956 - Trim Plate, MVP Hydra, #8 Mirror Finish

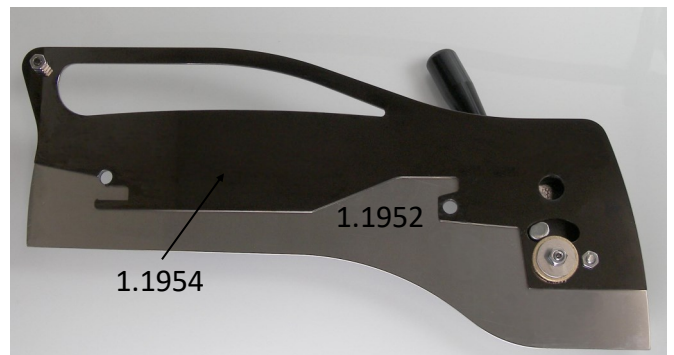
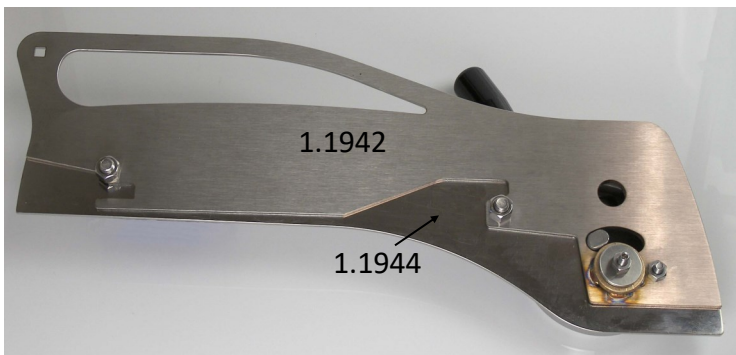

Body - Accessories and Components

Cup Drip Grates (per piece)
 1.1441 (3 Gp)
 1.1451 (2 Gp)
 1.1461 (1 GP)

Hot Water Spout Assembly



1.5152- Assembly 2 & 3 gp
 1.5153 - Assembly 1 gp
 1.5250 - Aerator for Hot Water Spout

1.1910 Sight Glass Window



1.8010 - Screw 1.8250- Nut

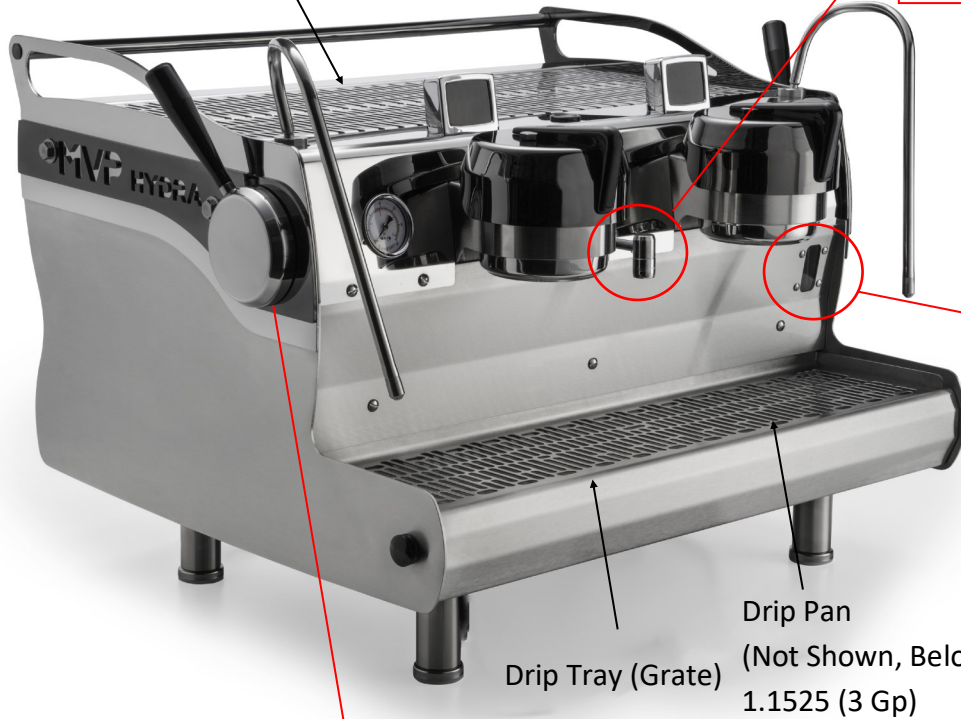

Drip Pan (Not Shown, Below Tray)
 1.1524 (3 Gp) 1.1525 (3 Gp)
 1.1534 (2 Gp) 1.1535 (2 Gp)
 1.1544 (1 Gp) 1.1545 (1 Gp)

Steam Actuator Handle
 1.4255 (w/ Set Screw)

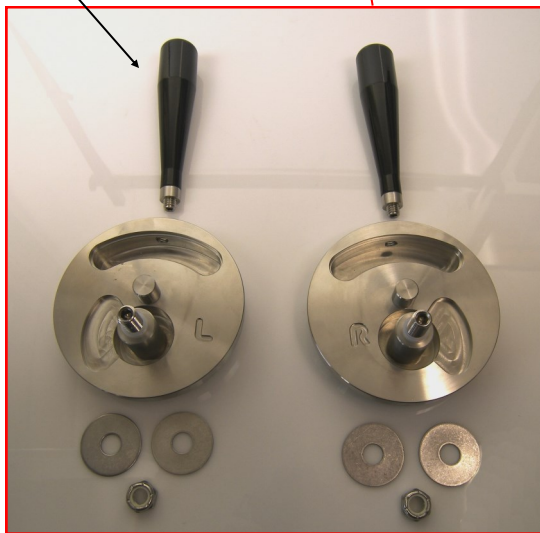

Stainless Steel Steam Actuator with Washers and Nylock Nut

2.5242- Left Hand
 2.5232 - Right Hand

Cup Drip Pan (Black)
 1.1481 (3 Gp)
 1.1491 (2 Gp)
 1.1501 (1 Gp)

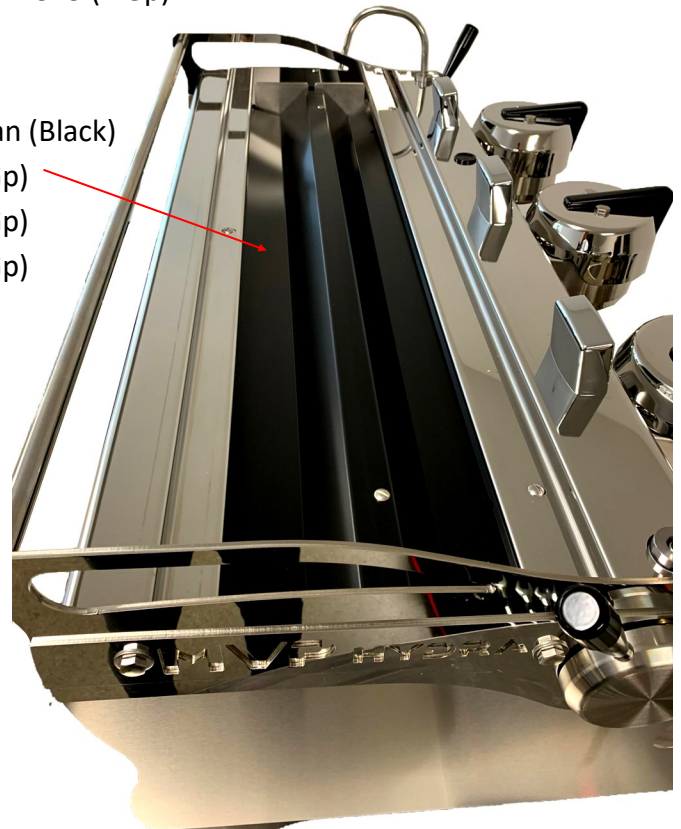

Body - Components and Hardware



2.3529 - Board, Housing, Springs & Acrylic Cover

*Numbers replaced "Dots", May 2016

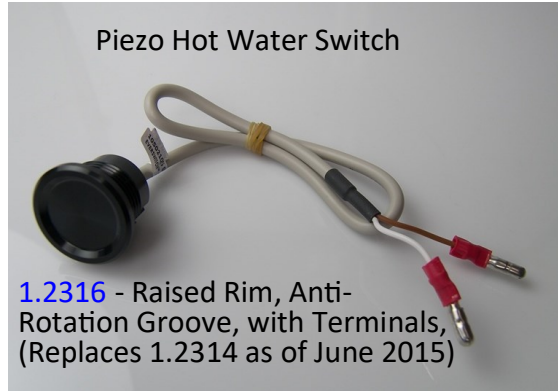

Piezo Hot Water Switch

1.2316 - Raised Rim, Anti-Rotation Groove, with Terminals, (Replaces 1.2314 as of June 2015)

MVP & MVP Hydra Legs - 1.1996

*Per our sanitation regulations, machines will be shipped with the leg in a 4" configuration. A shorter leg can be configured by removing one of the aluminum round bar posts.

1.1996 - Leg, 4" Assembly

1.8130 - Bolt

1.8510 - Split Washer

1.1992 - Round Bar

1.8320 - Set Screw

1.1992 - Round Bar

1.8290 - Nut

1.1993 Leg Sleeve (Cover)

1.1995 - Leg Base



1.1932 - Rubber Pad, 40 mm Diameter



1.8882 - Side Panel Knob Assembly (Thumb Screw)

1.1173 - Nut Plate / Guide for Side Panels

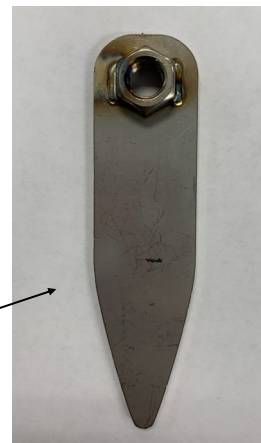

Brew and Steam Gauges



1.4083 - Steam Gauge
0-60 PSI with Fitting



1.3373 - Brew Gauge
0-300 PSI with Fitting

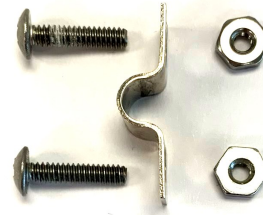

3.8300 - Gauge Hardware
Kit

Body Panels and Parts Descriptions

#8 - refers to a #8 Mirror polish on stainless steel / #4 - refers to a #4 Brushed polish on stainless steel
SS - means Stainless Steel / Gp - means Group / Ga. - refers to gauge or thickness of panel

Part #	Description
1.1045	Group Top Housing MVP Series (Skirt), (2015)
1.1173	Nut Plate / Guide for Side Panels
1.1351	Panel, Upper Back, 1 Group, #8 SS, MVP Series (2015)
1.1352	Panel, Upper Back, 2 Group, #8 SS, MVP Series (2015)
1.1353	Panel, Upper Back, 3 Group, #8 SS, MVP Series (2015)
1.1441	Cup Grate, 3 Group
1.1451	Cup Grate, 2 Group
1.1461	Cup Grate, 1 Group
1.1481	Pan, Cup Drip 3 Gp, Pwd Coat Bk, Aluminum
1.1491	Pan, Cup Drip, 2 Gp, Pwd Coat Bk, Aluminum
1.1501	Pan, Cup Drip 1 Gp, Pwd Coat Bk, Aluminum
1.1524	Drip Tray (Grate) 3 Gp
1.1525	Drain Pan, 3 Group, Stainless Steel, Passivated
1.1534	Drip Tray (Grate) 2 Gp
1.1535	Drain Pan, 2 Group, Stainless Steel, Passivated
1.1544	Drip Tray (Grate) 1 Gp
1.1545	Drain Pan, 1 Group, Stainless Steel, Passivated
1.1560	Panel, Front Lower, 3 Group, Stainless Steel,
1.1570	Panel, Front Lower, 2 Group, Stainless Steel
1.1580	Panel, Front Lower, 1 Group, Stainless Steel

Body Panels and Parts Continued (2)

Part #	Description
1.1659	Group Top Handle, Deco, Black, MVP Series (2015)
1.1701_1	Panel, Black Powder Coated, Back Grill, 1 Gp, MVP Series (2015)
1.1702_2	Panel, Black Powder Coated, Back Grill, 2 Gp, MVP Series (2015)
1.1703_3	Panel, Black Powder Coated, Back Grill, 3 Gp, MVP Series (2015)
1.1711	Panel, Back, Lower, #8 SS,1 Group, MVP Series (2015)
1.1712	Panel, Back, Lower, #8 SS, 2 Group, MVP Series (2015)
1.1713	Panel, Back, Lower, #8 SS, 3 Group, MVP Series (2015)
1.1721	Panel, Back, Inner, #8 SS, 1 Group, MVP Series (2015)
1.1722	Panel, Back, Inner, #4 SS, 2 Group, MVP Series (2015)
1.1723	Panel, Back, Inner, #4 SS, 3 Group, MVP Series (2015)
1.1732	Panel, Back, Synesso Logo, #8 SS, 2 Group, MVP Series (2015)
1.1733	Panel, Back, Synesso Logo, #8 SS, 3 Group, MVP Series (2015)
1.1782	Synesso "S" Logo, 4" Diameter, Cast & Polished (2015)
1.1853	Panel, Upper Front, 1 Gp, Timer Control, Mirror Polish, Stainless Steel, (2015)
1.1866	Panel, Upper Front, 2 Gp, Timer Control, Mirror Polish, Stainless Steel, (2015)
1.1867	Panel, Upper Front, Hydra 2 Gp, Timer Control, Mirror Polish, Stainless Steel, (2015)
1.1906	Panel, Upper Front, 3 Gp, Timer Control, Mirror Polish, Stainless Steel, (2015)
1.1907	Panel, Upper Front, Hydra 3 Gp, Timer Control, Mirror Polish, Stainless Steel, (2015)
1.1910	Sight Glass Window
1.1932	Leg Pad, Black Rubber, 40mm Round, Single
1.1941	Side Panel, MVP Top Inner Bearing Plate, LH, 12 Ga. #4 (2015)
1.1942	Side Panel, MVP Top Inner Bearing Plate, RH, 12 Ga. #4 (2015)
1.1943	Side Panel, MVP Outer Trim, LH, 12 Ga. #8 (2015)
1.1944	Side Panel, MVP Outer Trim, RH, 12 Ga. #8 (2015)
1.1945	Side Panel, MVP Series, Lower LH, 12 Ga. #4 (2015)
1.1946	Side Panel, MVP Series, Lower RH, 12 Ga. #4 (2015)
1.1951	Side Panel, MVP Hydra, Top Outer, LH, 14 Ga. #8 (2015)
1.1952	Side Panel, MVP Hydra, Top Outer, RH, 14 Ga. #8 (2015)
1.1954	Side Panel, MVP Hydra, Top Inner Bearing Plate, RH (2015)
1.1955	Side Panel, MVP Hydra, Outer Trim, LH, 12 Ga. #8 (2015)
1.1956	Side Panel, MVP Hydra, Outer Trim, RH, 12 Ga. #8 (2015)
1.1958	Side Panel, MVP Hydra 1 Group, Outer Trim,RH, 12 Ga. #8 (2015)
1.1992	Leg Post, Aluminum Round Bar
1.1993	Machine Leg Covers for 4"Legs, MVP Series Machines
1.1995	Leveling Adjustable Leg Base, 1 3/4" Diameter, MVP Series (2015)
1.1996	Leg, Adjustable 4", NSF compliant, MVP Series, (2015)
1.2316	Piezo Switch, Black Anodized mounting 24V AC/DC, O.2A, Paired Wires w/Bullet Connectors
1.3373	Gauge, Brew Pressure, 0-300 PSI + Fitting, Plain Face
1.4083	Gauge, Steam Pressure, 0-60 PSI + Fitting, Plain Face, Glass Lens
1.4255	Steam Valve Handle, MVP, 1' Aluminum, High Gloss Black Pwd Coat w Set Screw & Spacer

Body Panels and Parts Continued (3)

Part #	Description
1.4864	Ribbon Cable for Handheld Display, 1 Gp Only
1.5152	Hot Water Spout Assembly, 2 & 3 Gp
1.5153	Hot Water Spout Assembly, 1 Gp Only
1.5250	Aerator for Hot Water Spout
1.7235	Safari Rack, Cup Rail Tube, 3 Group, MVP (2015)
1.7245	Safari Rack, Cup Rail, Tube 2 Gp, MVP (2015)
1.7255	Safari Rack, Cup Rail, Tube 1 Gp, MVP (2015)
1.7579_1	Trim, 3 Sided Base, 1 Gp, Stainless Steel, #8 Finish (2015)
1.7579_2	Trim, 3 Sided Base, 2 Gp, Stainless Steel, #8 Finish (2015)
1.7579_3	Trim, 3 Sided Base, 3 Gp, Stainless Steel, #8 Finish (2015)
1.8010	Screws, 6-32 x 1/2" Truss Hd Slot, 18-8 SS,
1.8050	Screws, SS, 10-32 Truss Hd Slot 1/4"
1.8130	Bolt, SS, 3/8-16 Hex Hd Cap, 3/4"
1.8131	Bolt, MVP Series, Side Panel, 3/4" Hex Head Cap, Polished (2015)
1.8250	6-32 Hex Machine Nut SS
1.8290	Nuts, 3/8-16 Hex, 18-8 SS
1.8320	Set Screw, Cup Pt, 3/8-16 x 3/4, Thumbscrew, MVP Leg & Cynkra 2016, Gp Top Actuator
1.8440	Flat Washer, 3/8", 18-8 SS
1.8510	Split Lock Washer, 3", SS
1.8882	Side Panel Knob, (Thumb Screw) Black with O-Ring & Threaded Rod
2.3529	Digital Shot Timer & Control w/ Housing, MVP Series (2015)
2.3729	Display Board, Housing, Overly & Cable (2015) - Complete Replacement Part, 2 & 3 Gp Only
2.5232	Steam Actuator, RH, Stainless Steel, Nylock & Washer, NO Handle
2.5242	Steam Actuator, LH, Stainless Steel, Nylock & Washer, NO Handle
3.1157	Side Panel Assembly, Upper RH, 1 Gp, MVP Hydra
3.1941	Side Panel Assembly, Upper LH, MVP Hydra
3.2379	Handheld Display
3.8015	Bolt, Side Panel, Polished Stainless, MVP (2015)
3.8020	Bolt, Group Top, Polished Stainless, MVP (2015)
3.8300	Gauge Hardware Kit

Group Top Assembly

1.1014 - Group Top for All MVP Series Machines

1.1659 - Group Top Handle, Black

3.8020 - Polished, SS, Bolt, MVP Gp Top



3.1013 - Group Top Assembly Polished Stainless Steel



1.3381 - Bayonet Ring



3.1032 - Skirt Assembly, MVP Series

1.8050 - Screw

1.8260 - Nut

1.1045 - MVP & MVP Hydra Skirt (Housing)

Bayonet Hardware

1.8475 - Washer

1.8500 - Split Lock Washer



1.8110 - Bolt

Group Top Actuator Assembly

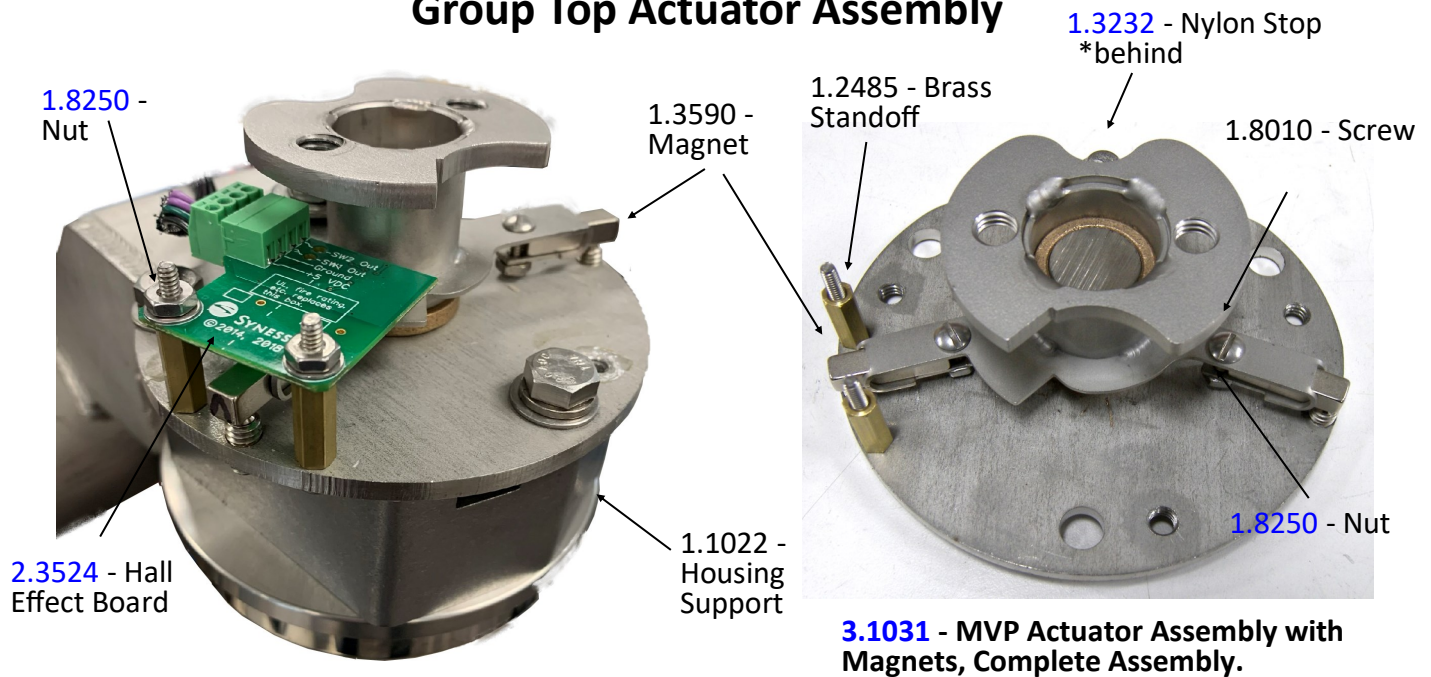

1.1135 - MVP & MVP Hydra Group Top Assembly with Hall Effect Board, Mount Plate, Skirt, Magnets & Hardware

Group Top Assembly

1.1014	Group Top, MVP, Stainless Steel, Polished (Handle not included)
1.1022	Group Top Housing Support
1.1045	Group Top Housing MVP Series [Skirt Only], (2015)
1.1046	Group Top Mount Plate, MVP Series, (2015)
1.1135	Group Top Housing, Hall Effect, MVP Series (2015)
1.1659	Group Top Handle, Deco, Black, MVP Series (2015)
1.2485	Spacer for Paddle Shifter, Brass, MVP Series(2015)
1.3381	Bayonet Ring, 300 Series Stainless, Cast
1.3590	Magnets, 1x1/4x1/4 Neodymium Rare Earth for Actuator Detents
1.8010	Screws, 6-32 x 1/2" Truss Head Slot, 18-8 SS
1.8050	Screws, SS, 10-32 Truss Head Slot 1/4"
1.8110	Bolt, SS, 5/16-18 Hex Head Cap, 2 1/2"
1.8250	Nuts, SS 6-32, Hex, SS (5/16" width)
1.8260	Nuts, SS, 10-32 Hex
2.3524	Hall Effect Board, MVP Series (2015)
3.1031	Actuator Assembly, MVP Series
3.1032	Skirt, MVP Series, Includes Screws and Nuts
3.8020	Bolt, Group Top, Polished Stainless, MVP Series

Major Components, Water Inlet (Right Side)

*Shown: MVP Hydra 2 Group, Water Inlet (Right Side)

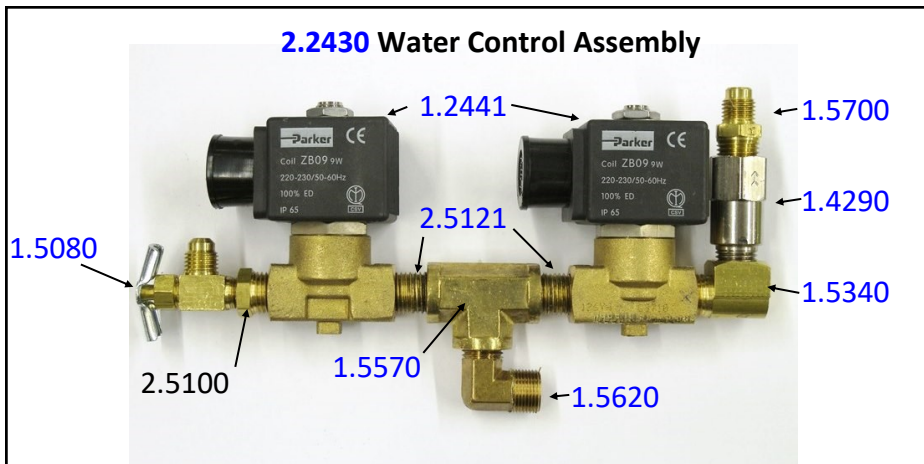
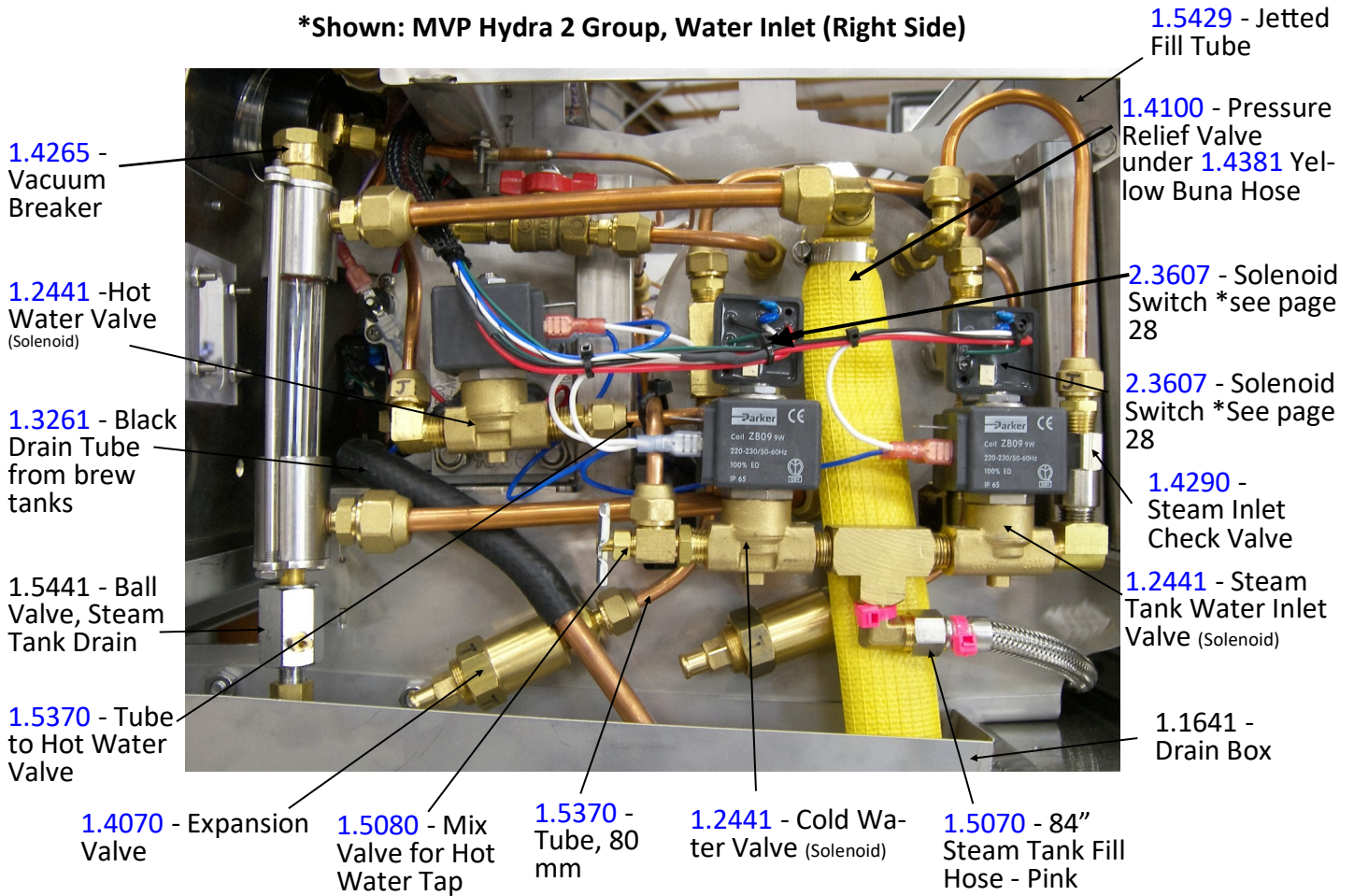

1.5429 - Tube, 1/4' Copper, Jetted Steam Tank Fill

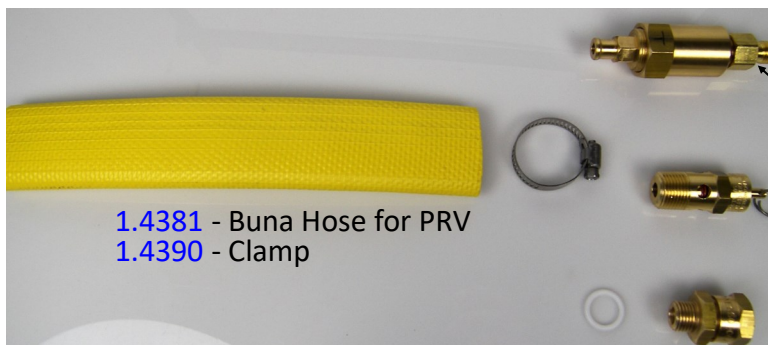

1.4070 - Expansion Valve

1.5540 - Brass Fitting for Expansion Valve

1.4100 - Pressure Relief Valve

1.4265 - Vacuum Breaker w/ O-Ring

Tubes, 1 Group MVP Hydra, Right Side

1.6900 - Tube, Hot Water to Tee, 65 mm, 1 Gp

1.6751 - Tube, Heat Exchange Jumper, 178 mm

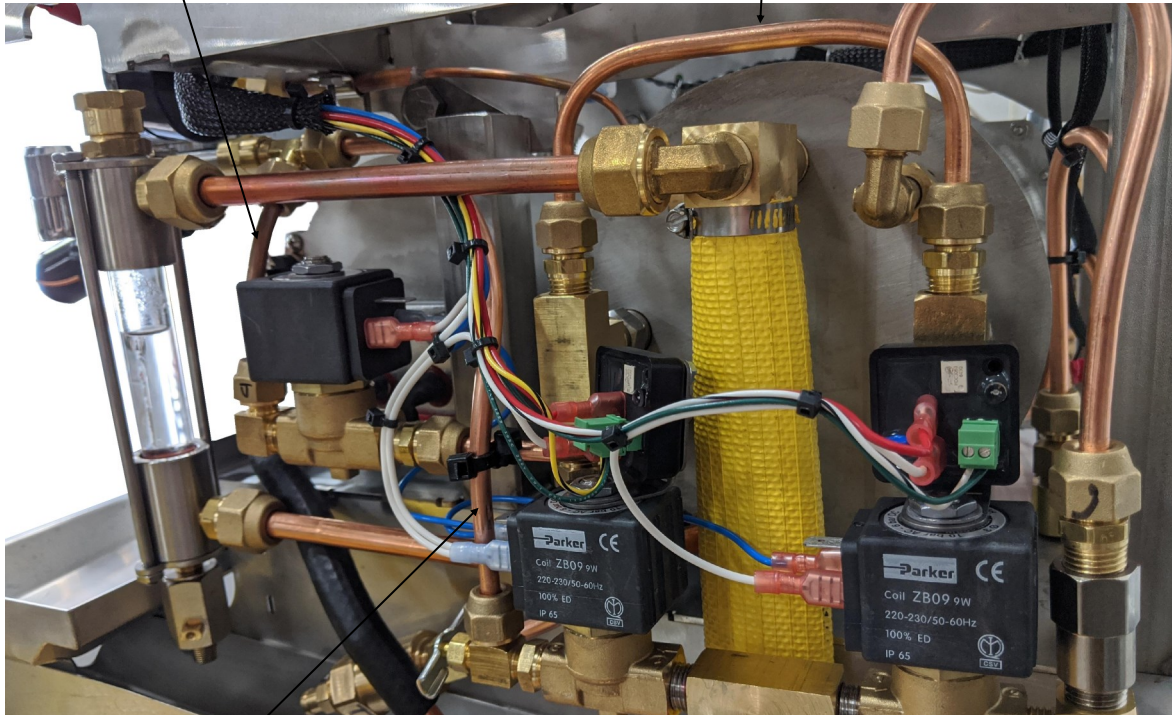

1.6910 - Tube, Cold Water to Tee, 195 mm, 1 Gp

Tubes, MVP Series, Top View

*Shown: MVP Hydra 2 Group

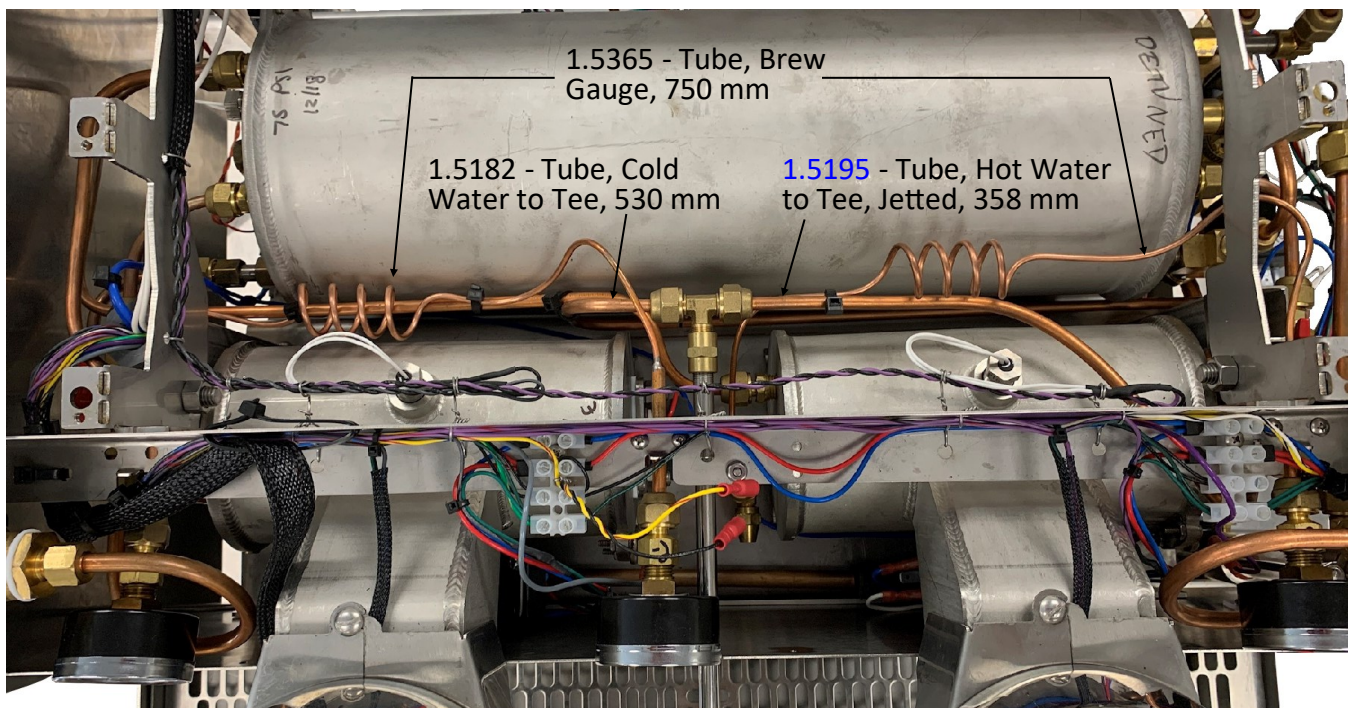

Hot Water Assemblies and Fittings

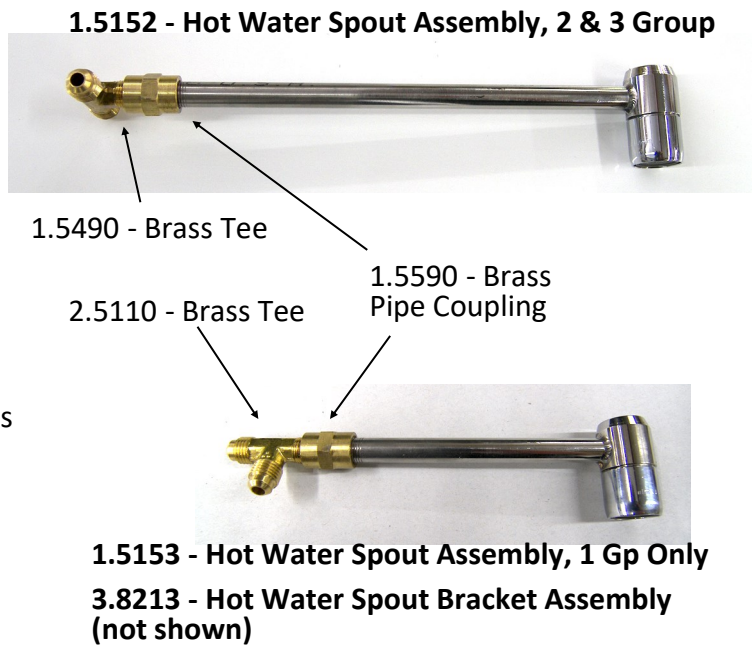
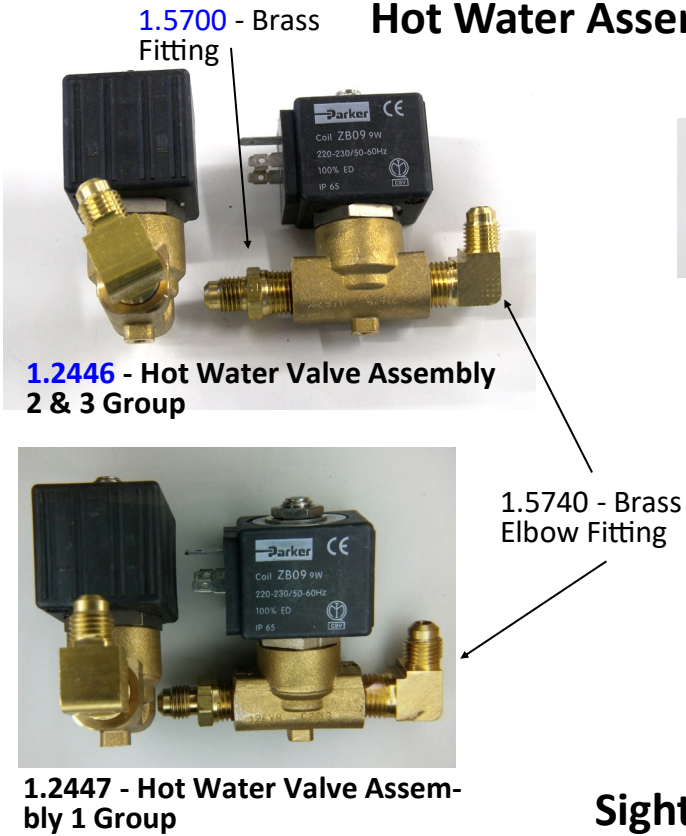

Sight Glass

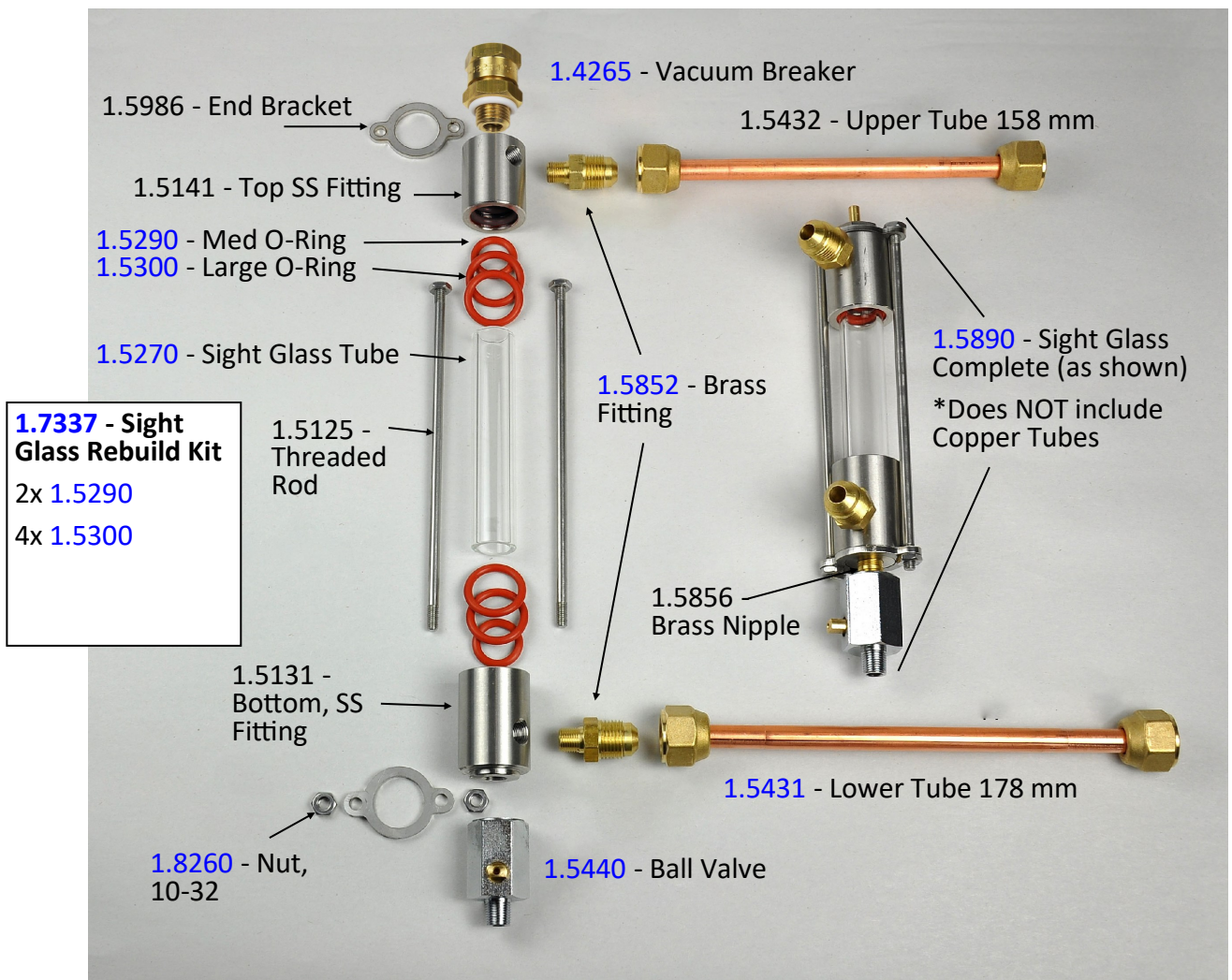

Steam Assembly

1.4161 Steam Wand Assembly

*Steam Tip Sold Separately

1.4160 - Steam Wand

1.4133 - Nut and Gasket

1.4132 - Spool and O-ring

1.4321 - O-ring
Wand Ball

1.4133 - Nut
and Gasket
(1.4123)

1.4321 Wand Ball
O-Ring

1.4131 - Spool

1.4310 - Spool O-ring

1.4140 - Spring

1.4350 - Spring

1.4505 - Seal
Holder

1.4122 - Teflon
Gasket

1.4200 - Seal
for Seat

1.4181 -
O-rings

*Steam Tip
Sold Sepa-
rately

1.7320—Steam Valve Rebuild Kit

1.4505

1.4200

1.4122

1.4123

1.4310

1.4321

1.4181

1.4501 - Steam
Valve, Brass with
Teflon Gasket.
Pusher is Sold Sep-
arately



1.4612 - Steam Valve
Pusher, For Black Cast
and Current Stainless
Handles



Stainless Steel, Steam Wand Tips



1.4171 - 6 Hole

1.4172 - 4 Hole



1.4133 - Steam Wand Nut
and O-Ring Assembly



1.5232 - Tube to Steam
Valve, Left Side



1.5231 - Tube to Steam Valve,
Right Side

Brew Inlet and Flowmeter Configurations for MVP

***MVP & MVP Hydra use a 4 Magnet Flowmeter**

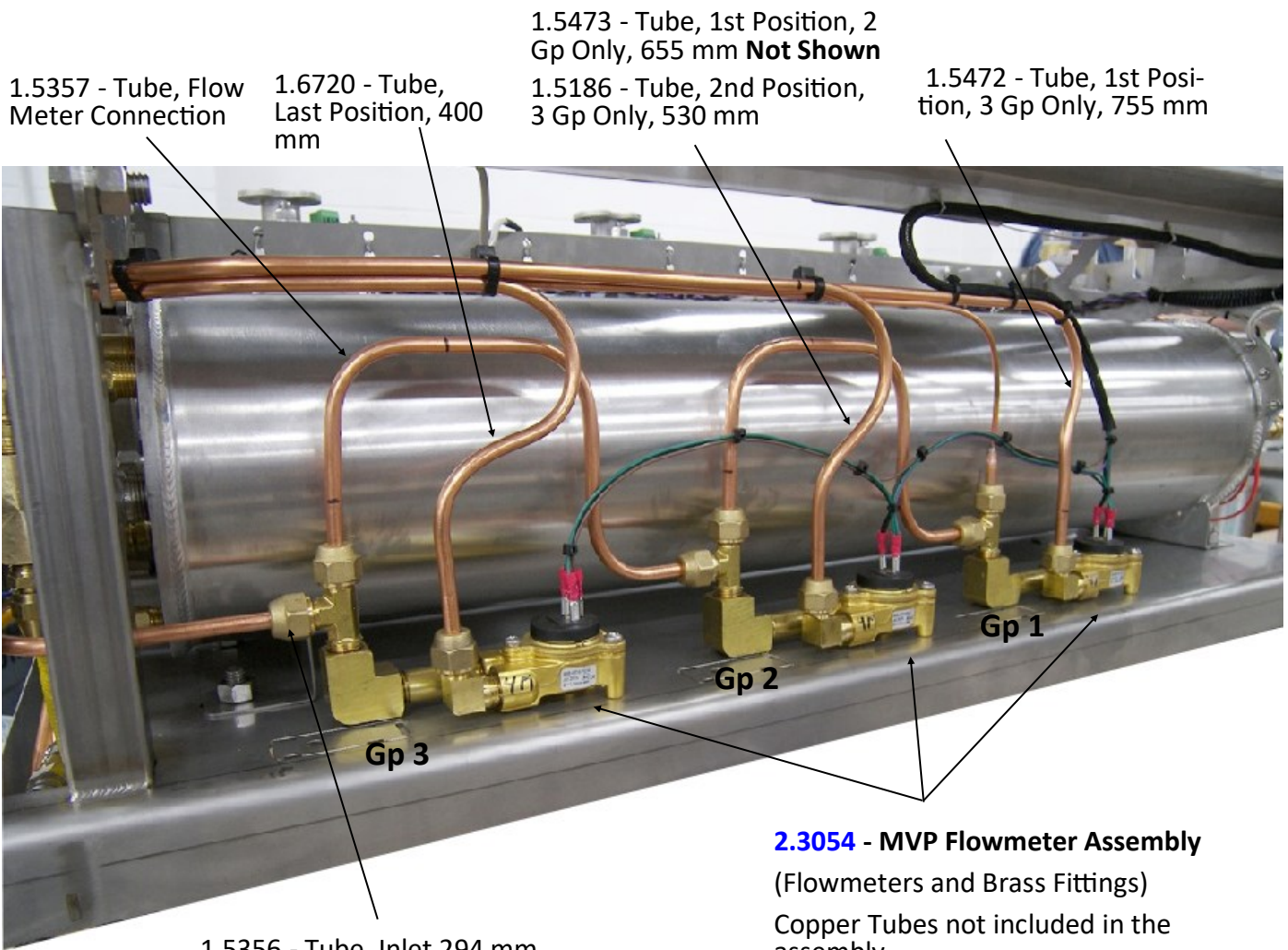

2.3054 - MVP Flowmeter Assembly
(Flowmeters and Brass Fittings)
Copper Tubes not included in the assembly.

2.2440 - MVP Inlet Assembly
***Not Shown Above**

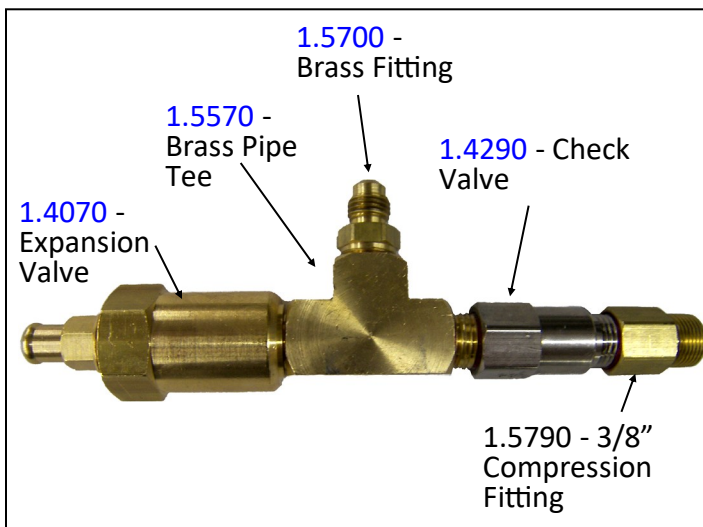

2.5111 - Brass Run Tee

2.3057 - Flow Meter, 4-Magnet

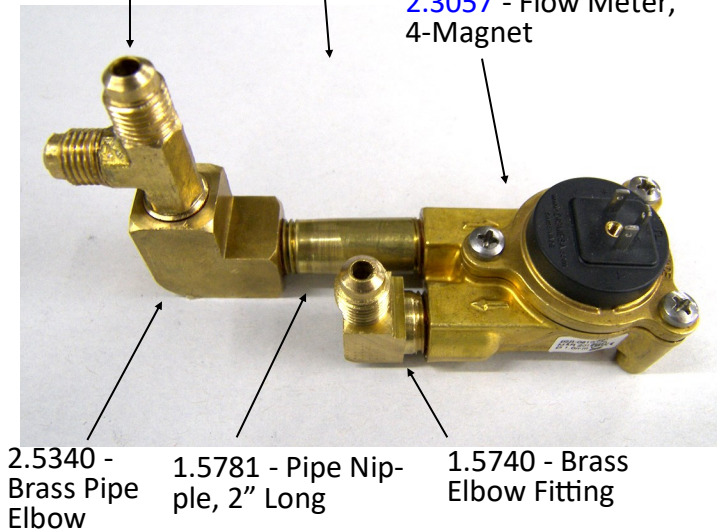

Brew Inlet and Flowmeter Configurations for MVP Hydra

***MVP & MVP Hydra use a 4 Magnet Flowmeter**

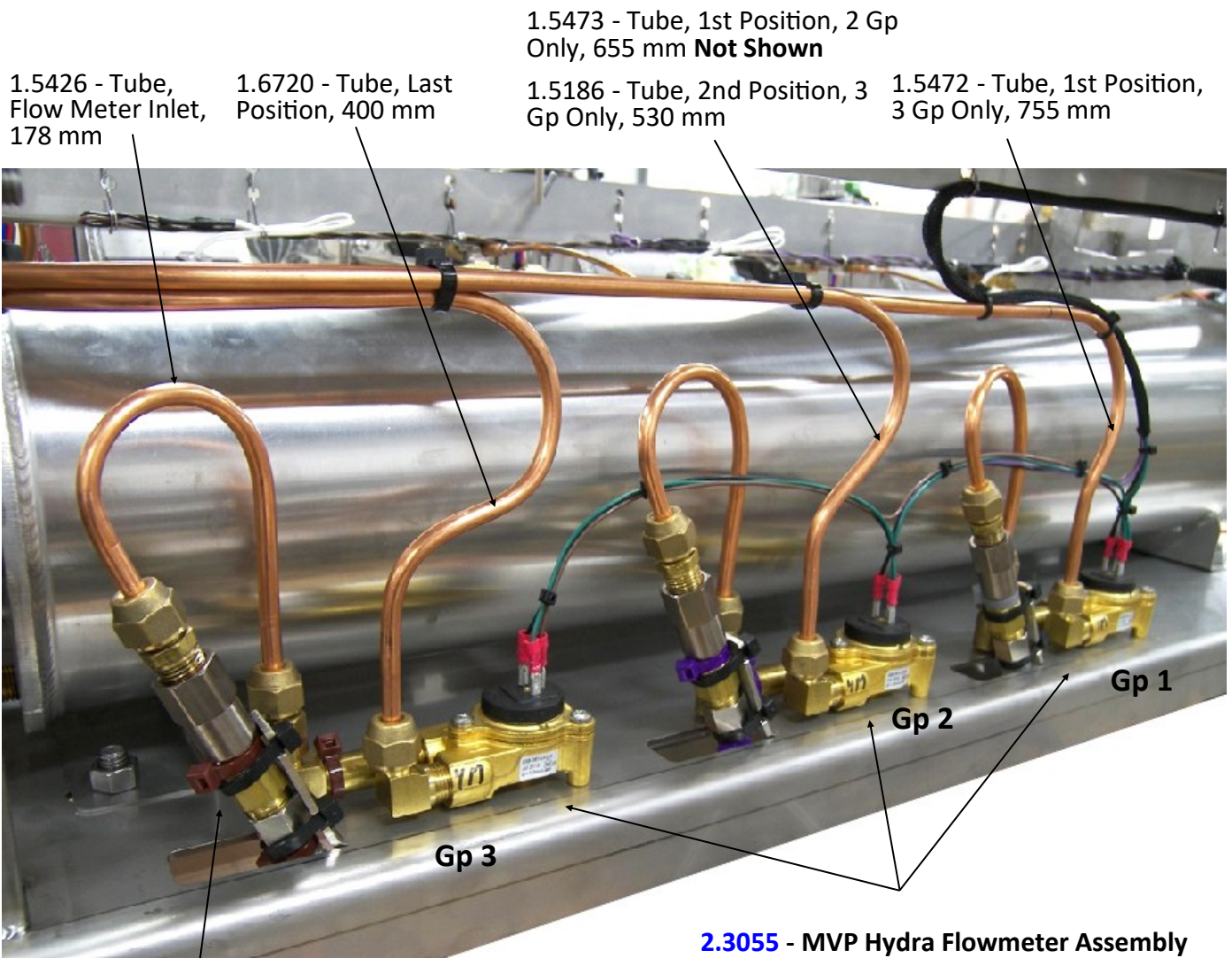

2.3055 - MVP Hydra Flowmeter Assembly
(Flowmeters and Brass Fittings. Copper Tubes Not Included in the Assembly.)

2.2420 - Brew Inlet Assembly



1.5700 - Brass Fitting
1.4290 - Check Valve, 1/4", 1 Per Group
1.5790 - Brass Fitting, 3/8" Compression

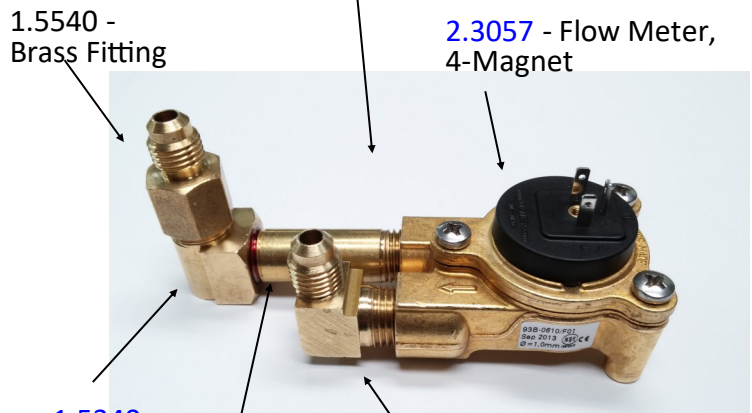

1.5540 - Brass Fitting
2.3057 - Flow Meter, 4-Magnet
1.5340 - Brass Elbow Fitting
1.5781 - Pipe Nipple, 2" Long
1.5740 Brass Elbow Fitting

Brew Inlet and Flowmeter Configurations for 1 Group MVP Hydra

1.5426 - Tube,
Flow Meter Inlet,
178 mm

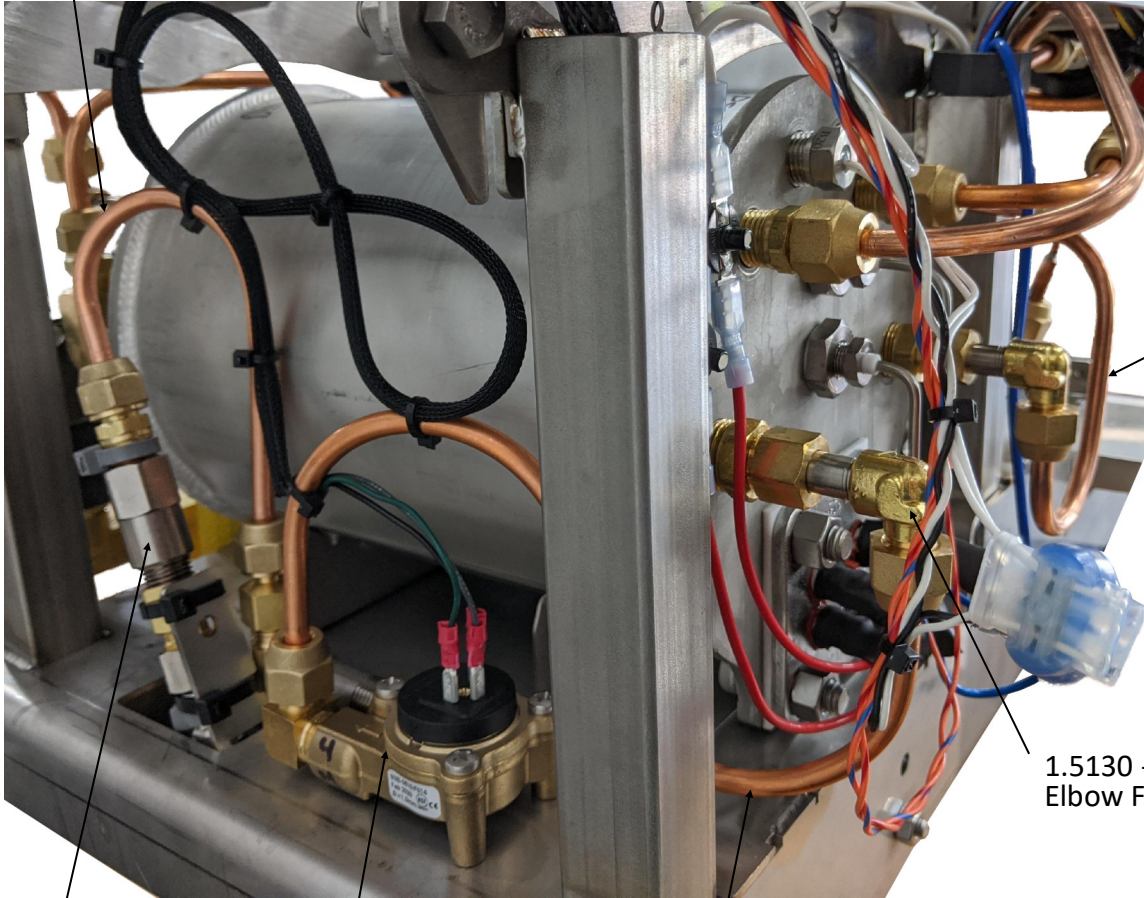

1.5422 - Tube,
Group Inlet, 1
Gp Only

1.5130 - 90 Degree
Elbow Fitting

2.2420 - Brew Inlet Assembly

1.5358 - Tube, Flow Meter to
Heat Exchange, 294 mm, 1 Gp

2.3055 - MVP Hydra Flowmeter Assembly
(Flowmeters and Brass Fittings. Copper Tubes
Not Included in the Assembly.)

Major Components, Water Outlet (Left Side)

*Shown: MVP or MVP Hydra - Oct 2015

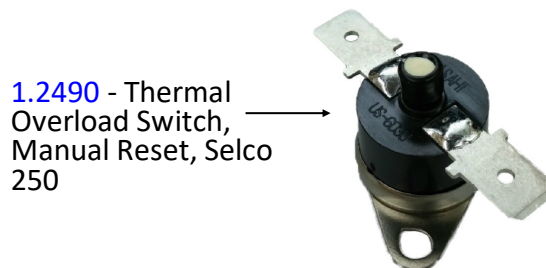
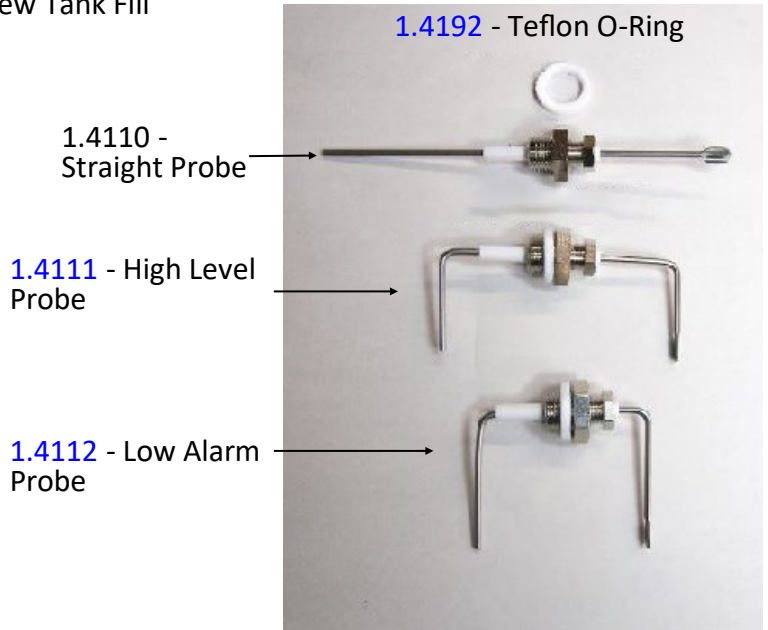
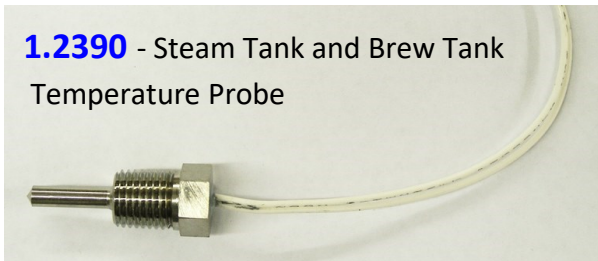
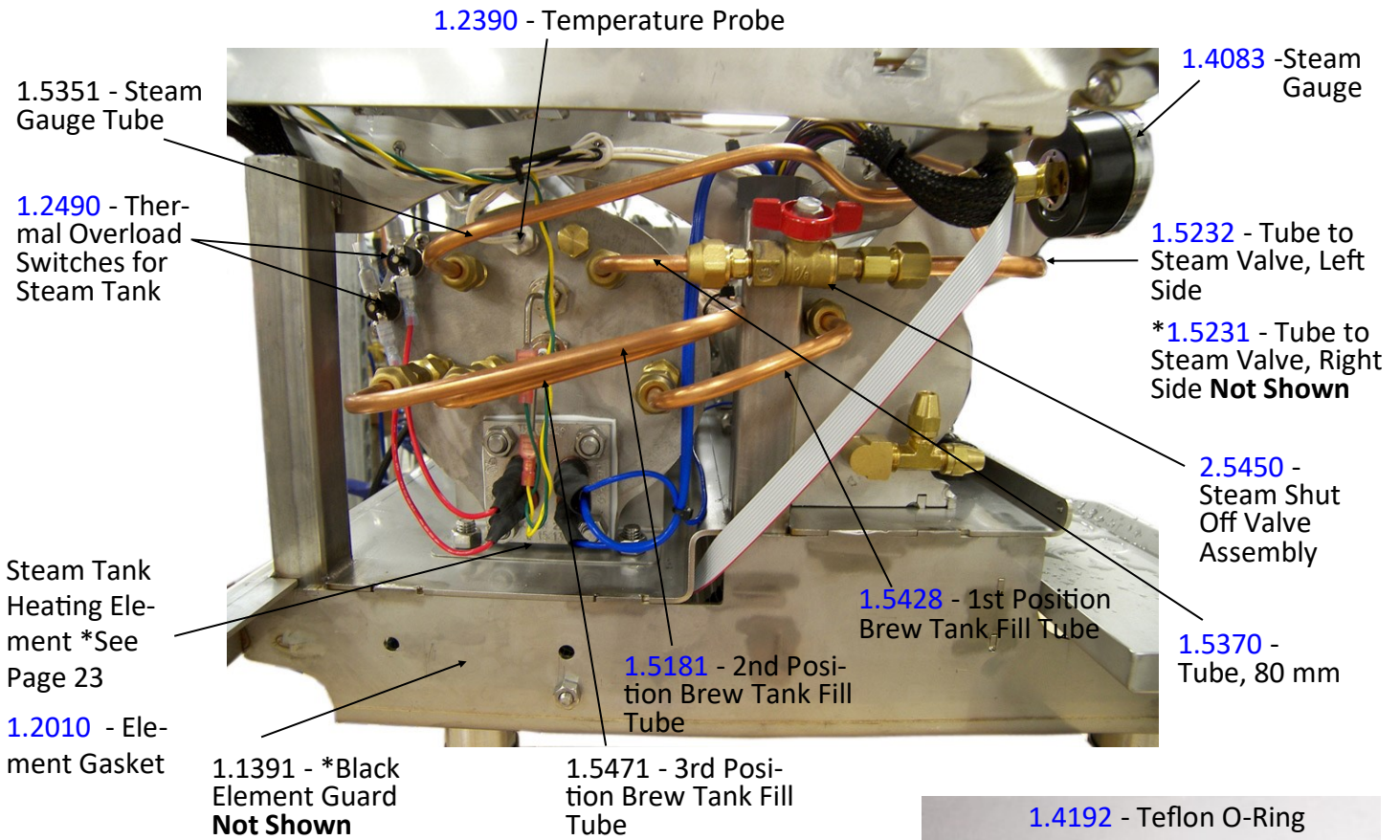

Universal Steam Tank Assembly, Right Side

*Shown: 2 Group Universal Steam Tank, Left Side, Fittings Only

1.5853 - Elbow, 3/8" OD x Male Pipe 3/8"

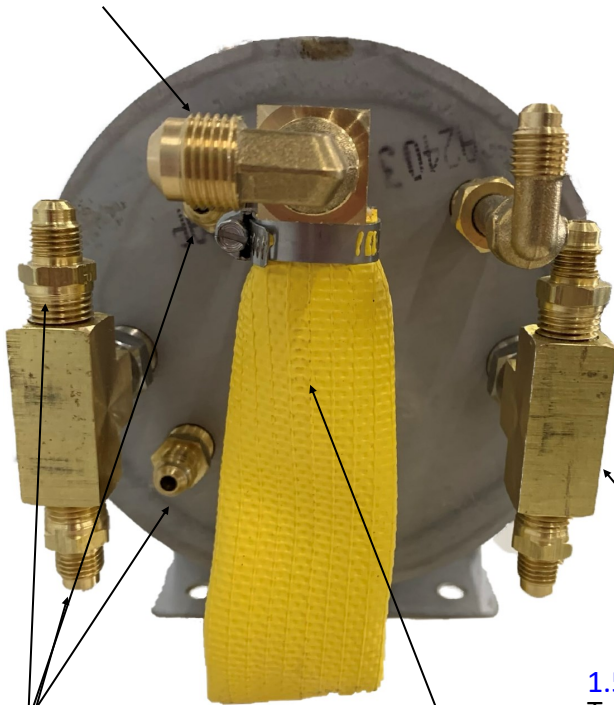

1.5700 - Fitting, 1/4" Flare x 1/4" Male Pipe

1.4100 - PRV *Under Hose
1.4381 - Hose
1.4390 - Clamp

1.5855 - Brass Pipe Tee, 3/8" Female

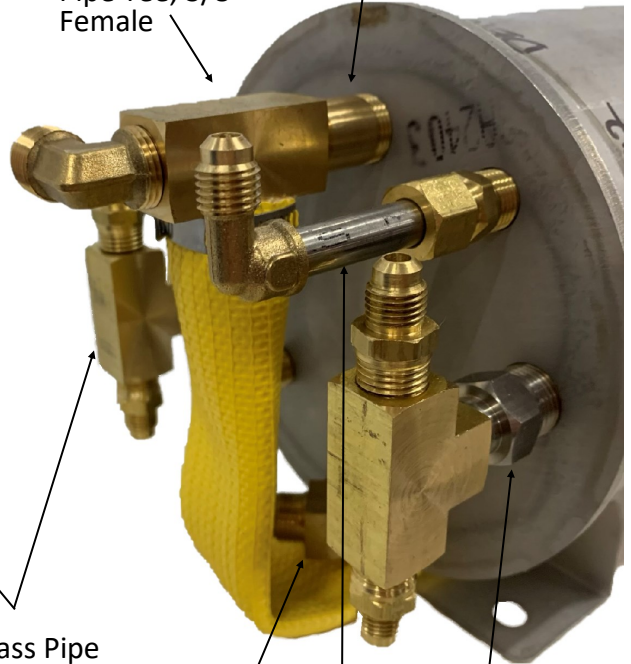

1.5950 - Close Nipple 3/8"x1.5"

1.5570 - Brass Pipe Tee, 1/4" NPT Female

1.5851 - 45 deg Elbow, 3/8" OD x Male Pipe 1/4"

Heat Exchange Tube *See pg 23

- 3.4501 - Universal Steam Tank Assembly, 1 Gp
- 3.4502 - Universal Steam Tank Assembly, 2 Gp
- 3.4503 - Universal Steam Tank Assembly, 3 Gp

1.4435 - Steam Tank Fill Tube Assembly



Universal Steam Tank, Left Side, Other Components Included but Not Shown Above:

- 1.2446 - Hot Water Valve Assembly
- 1.5370 - Tube, 1/4" Copper, 80mm (to hot water valve)
- 1.5431 - Lower Sight Glass Tube, 3/8" 178 mm
- 1.5432 - Upper Sight Glass Tube, 3/8" 158 mm
- 1.5890 - Sight Glass Complete
- 2.5450 - Steam Shut Off Valve Assembly

Universal Steam Tank Assembly, Left Side

*Shown: 2 Group Universal Steam Tank, Left Side

1.4533 - Steam Tank, 1 Gp, Tank Only
 1.4523 - Steam Tank, 2 Gp, Tank Only
 1.4513 - Steam Tank, 3 Gp, Tank Only
***Bare tanks are untested and not warrantied**

1.8011 - Screw 6-32, 5/8"
 1.8250 - Nut, 6-32
 1.8410 - Flat Washer, #6, Center Only

1.2490 - Thermal Overload Switch, Selco 250

1.2390 - Temp Probe
 1.5750 - Brass Plug
 1.5700 - Fitting

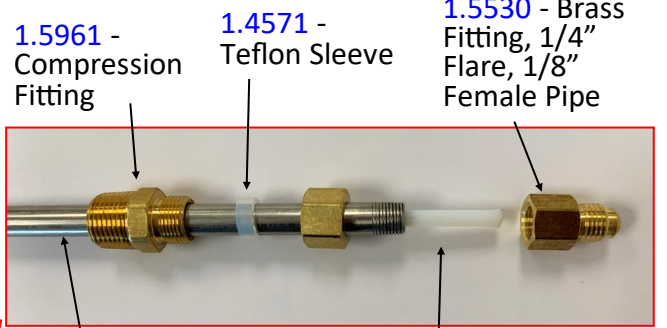

Heat Exchange Tube
 2.4539 - 1 Group
 2.4529 - 2 Group
 2.4519 - 3 Group
 Teflon Detuning Tube
 1.4453 - 1 Group, 2x Tubes
 1.4451 - 2 Group, 2x Tubes
 1.4452 - 3 Group, 3x Tubes
 Teflon Detuning Tube, Bulk
 1.4456 - Sold by the Foot

Steam Tank Elements, 220V, Incoloy 800®,
 1.2030 - 5000 Watts, 3 Group
 1.2040 - 4000 Watts, 2 Group
 1.2050 - 2000 Watts, 1 Group



1.4111 - High Level Probe
 1.4112 - Low Alarm Probe

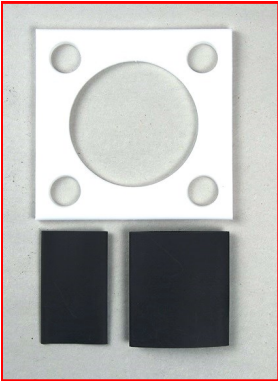

1.8290 - Nut, 3/8-16

1.2010 - Teflon Gasket for Heating Elements
 1.3821 - Heat Shrink, 1/2" Wide, 1.5" Long - Used to Protect a Single Wire Attached to the Element Post
 1.3861 - Heat Shrink, 3/4" Wide, 1.5" Long - Used when 2 Wires are Attached to an Element Post

Universal Brew Tank Assembly

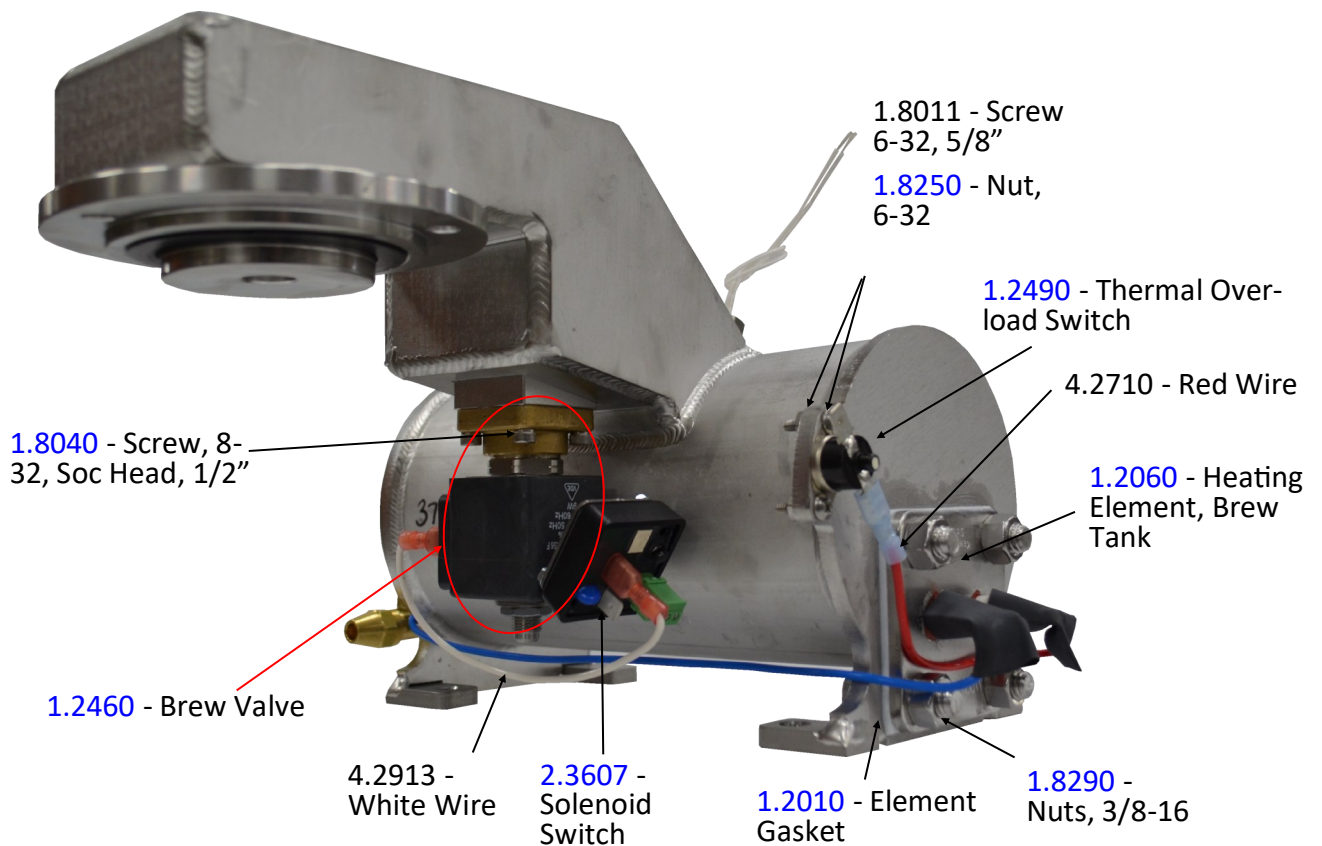

3.3135 Complete Brew Tank with Element, Brew Valve, Temp Probe, and Fittings

2.4622 - New Style Brew Tank Replacement, (Tank and Brass Fittings Only)

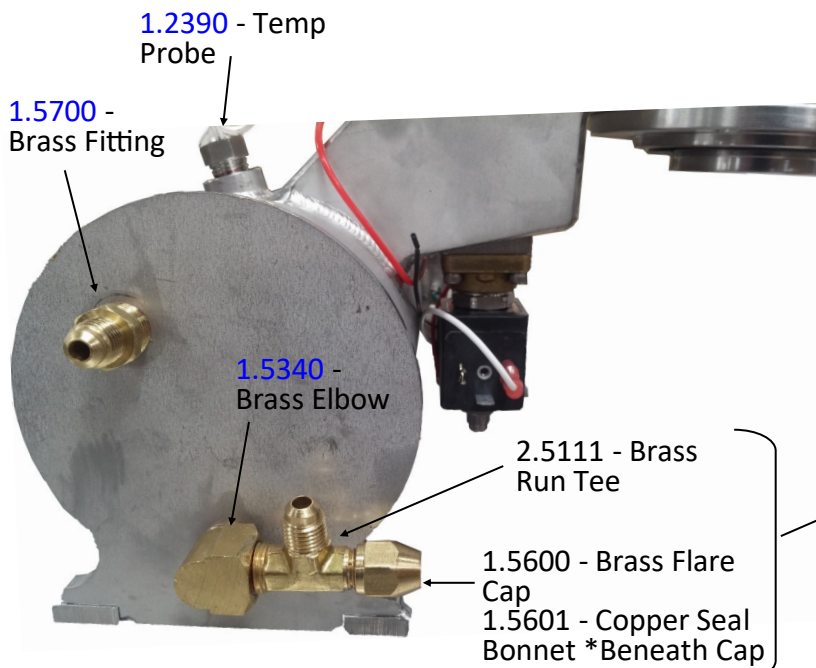

1.5445 - Brew Tank Drain, Dual Cap



1.5443 - Brew Tank Drain, Single Cap (For Hydra Gauge Tube)

Universal Brew Tank Assembly Components

Components Included in 3.3135 - Tank Assembly:

- 1.2010 - Heating Element Gasket
 - 1.2060 - Element, Brew Tank, 220V, 700 Watts, Incoloy 800®
 - 1.2390 - Temperature Probe, 2k Ohm
 - 1.2460 - Brew Valve, 220v
 - 1.2490 - Thermal Overload Switch, Manual Reset, Selco 250
 - 1.3192 - Ruby Jet, .6mm
 - 1.3821 - Heat Shrink Tube for Elements
 - 2.3607 - Solenoid Switch with Mounting Plate
 - 1.3441 - Portafilter Gasket, 8.5mm Standard
- Various Fittings, Fasteners, and Wires *See Parts Indicators on Previous Page



1.2060 - Brew Element, 700 Watts



1.2460 - Brew Valve, 220V, Ruby Seat, F Class

1.7400 - Brew Valve O-Ring



1.3191 - .6mm Ruby Jet Kit for Brew Valve

1.3196 - .8mm Ruby Jet Kit for Brew Valve

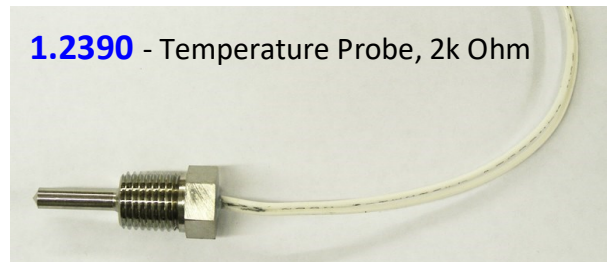

1.2390 - Temperature Probe, 2k Ohm

1.2490 - Thermal Overload Switch, Manual Reset, Selco 250



Standard Gasket *See page 34 for more options



1.3441 - 8.5 mm Portafilter Gasket, Standard Size

Drain Tubes and Manifold Assemblies

Copper Drain Manifold

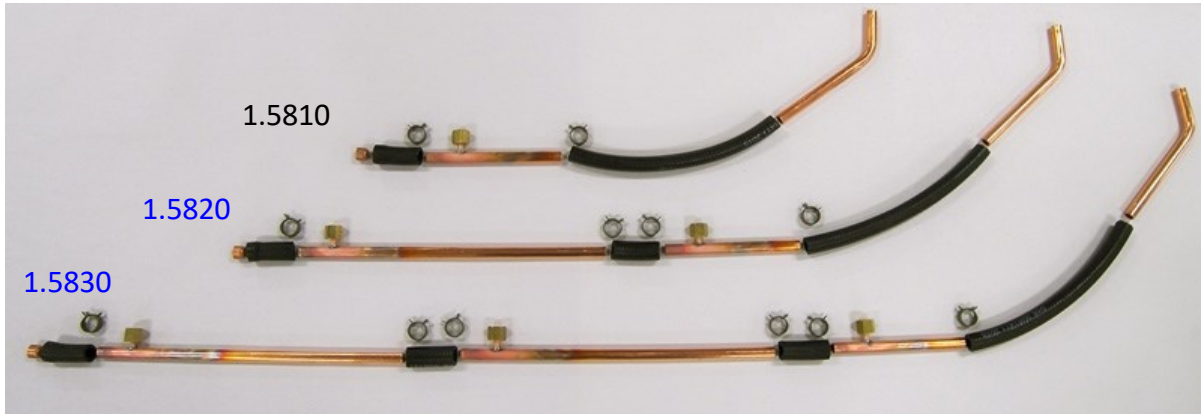

- 1.5810 - 1 Group Machines
- 1.5820 - 2 Group Machines
- 1.5830 - 3 Group Machines



1.5803 - Spring clamp. Added to manifold 3-2016

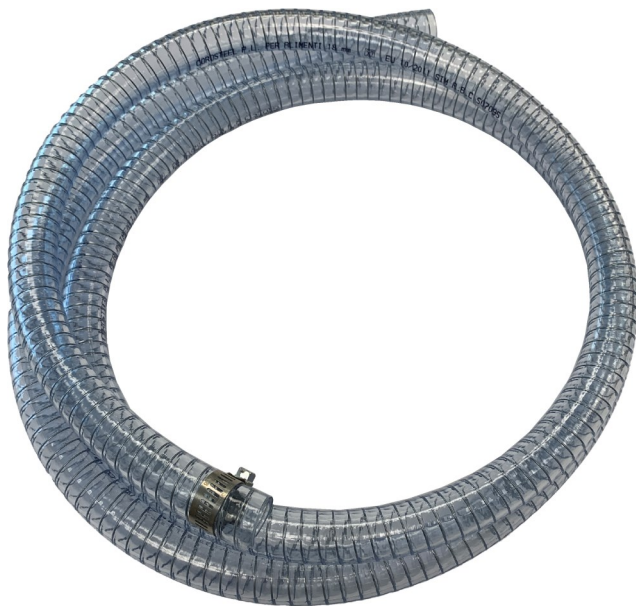

- 1.3310 - Drain Hose, 3/4" OD, Sold by the Foot
- 1.3311 - Drain Hose, 3/4" OD, Flexible, 8.3 ft
- 1.3320 - Drain Hose Clamp, 7/16"x1"



- 1.3261 - Black Hose, Bulk, Sold by the Foot
- 1.3262 - Copper Drain Manifold Connection Piece, 2"
- 1.3263 - Manifold to Drain Box, 7.5" Piece
- 1.3268 - End Cap Assembly, Includes Hose, Clamp & Copper Cap

Electronic Display Components

Handheld Display

*Replaces Discontinued Handheld Display Part 2.3701



2.3729 - Complete Display Controller with Cable 2&3 Gp

2.3729 Includes:

- 1.4863 - Ribbon Cable, 20 Pin Round, for Handheld Display, with Molded Ends
- 3.2379 - Handheld Display Assembly

*For 1 Group Machines order:

- 1.4864—Ribbon Cable, 20 Pin Round, for Handheld Display, with Molded Ends, for 1 Gp Machines
- 3.2379 - Handheld Display Assembly

2.3720 - Display Board for Handheld Controller



Digital Shot Timers

2.3523—Digital Shot Timer Control Board with LED Digits, (Housing and Cover Not Included)



2.3529 - Shot Timer Board, Housing, Springs & Acrylic Cover

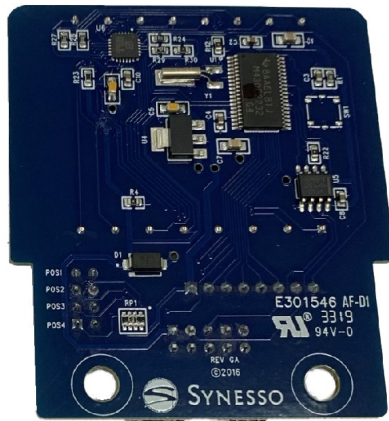

2.3529 Assembly Includes:

- 2.3520 - Timer Control Casing , Zinc, Polished
- 2.3526_R1 - Acrylic, Smoke Grey Cover
- 2.3523 - Shot Timer Control Board with LED Digits
- 2.3527 - Retainer for Timer (Spring)

Shot Timers with Cables Assemblies:

- 2.3529_1 - 1 Gp Machine
- 2.3529_2 - 2 Gp Machine
- 2.3529_3 - 3 Gp Machine

Shot Timer Replacement Ribbon Cables:

- 2.3511—1 Group Machine
- 2.3512—2 Group Machine
- 2.3513—3 Group Machine



Electrical Switches and Relays

Solenoid Switches (Pre-Wired)

*No Longer Available. Order [2.3607](#)

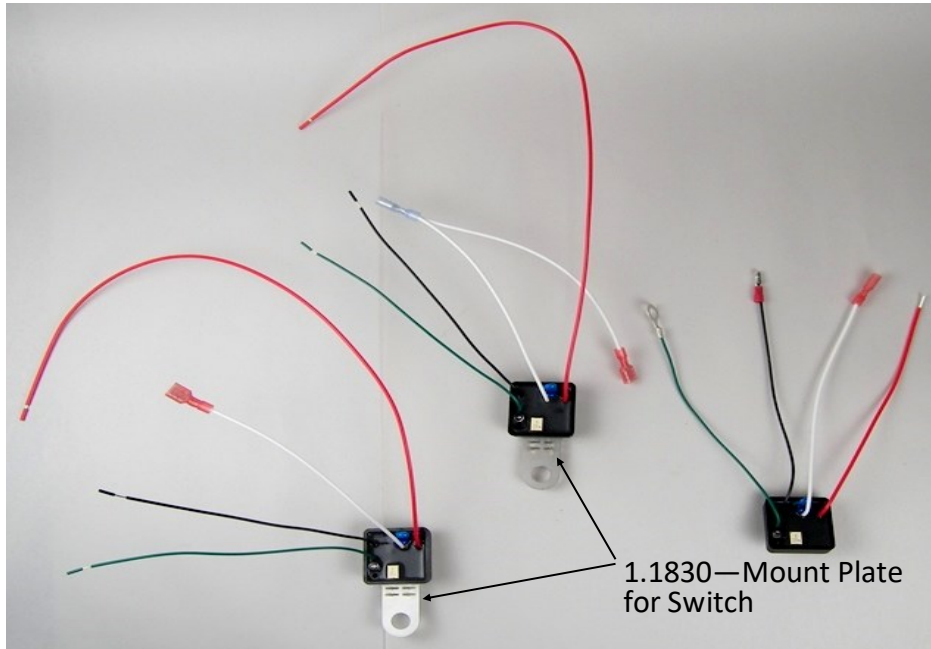

1.1830—Mount Plate for Switch



1.3740 - Solid State Low Voltage Relay, 40 amp. Used on Electrical Box Lids to Switch the Brew and Steam Elements.



2.3607- Solenoid Switch with Removable Terminal Connector *For Machines After Serial Number xxxxx5683

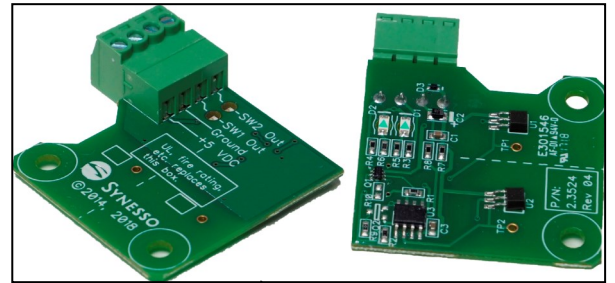

2.3524 - Dual Hall Effect Board



1.3752—Low Voltage Solid State Relay *Only For Machines After Serial Number xxxxx4080



1.3751—High Voltage Solid State Relay, 50 Amp *Used on Machines After Serial Number xxx3292



1.2133 - Deltron Pump Motor Relay, 208/240 Volts *No Longer Available. Upgrade Relay to High Voltage Solid State ([1.3751](#))



Electrical Box and Main Electronics Board

Shown: Electrical Box, 3 Group MVP Hydra, Dec 2017

1.3740 - Relay, Solid State, Low Voltage

2.3802 - Main Electronics Board

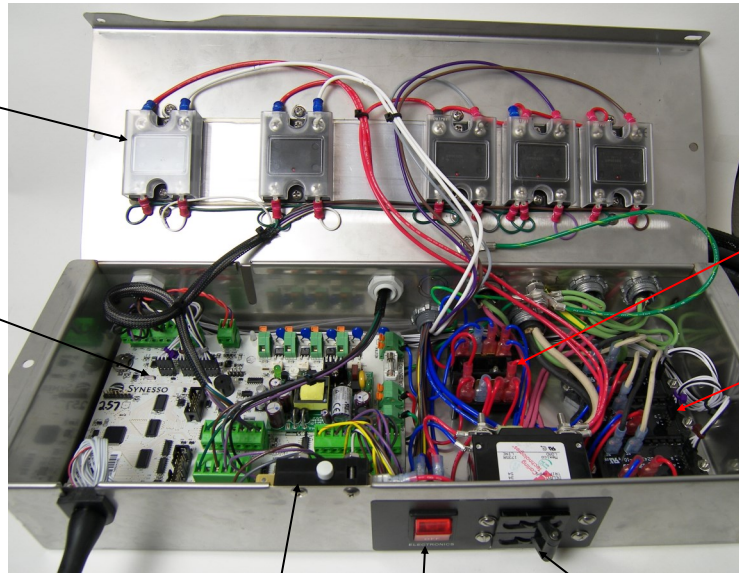

1.2585 - Power Distribution Block

1.3752 - Relay, Solid State, Low Voltage, Pump Motor

1.2430 - Safety, Interlock, Lid Switch

1.2420 - On/Off Electronics Switch

1.2631 - 40 Amp Element Breaker, 3 Gp Machines

1.2621 - 30 Amp Element Breaker, 2 Gp Machines **Not Shown**



1.3125 - Heat Sink, Aluminum for Lid Relays

2.3802 - Main Board, Programmed with MVP Series File, v2.64

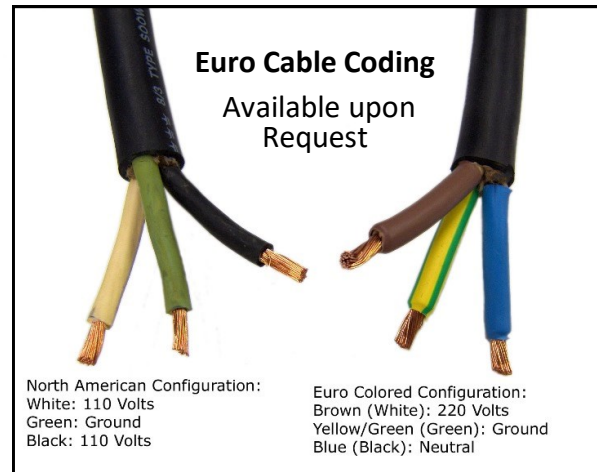
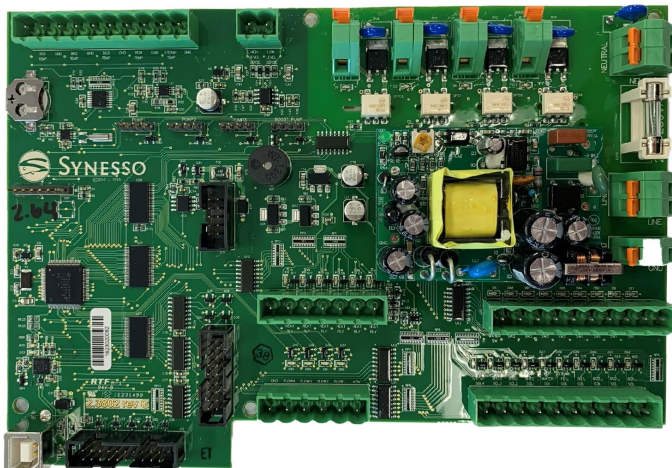

Pressure Regulator and Manifold



Pressure Regulator Manifolds currently used on line boost systems or as an accessory for MVP machines. Mini regulator replaced 1.7630—Watts pressure regulator. Manifolds stopped being used on MVP Hydras when the regulator was integrated into the bypass pump assemblies from machine #xxxx3913.

1.7648—1 Group MVP Hydra

1.7646—2 Group MVP Hydra

1.7647—3 Group MVP Hydra

* 1.7634-Mini Pressure Regulator only with no fittings

1.7634-Pressure Regulator



*Discontinued Watts Pressure Regulator

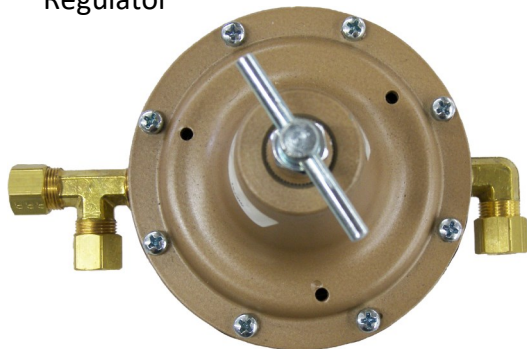

MVP Hydra Manifolds



1.7629—1 Grp. Manifold

1.7632—2 Grp. Manifold

1.7633—3 Grp. Manifold

1.5020 - Euro Hose and Fitting Kit

North American Hose is 3/8" Compression

European is 3/8" BSP Parallel



1.5000 - Euro Fitting / 1.5010 - Euro Hose

Pump Bypass Assemblies

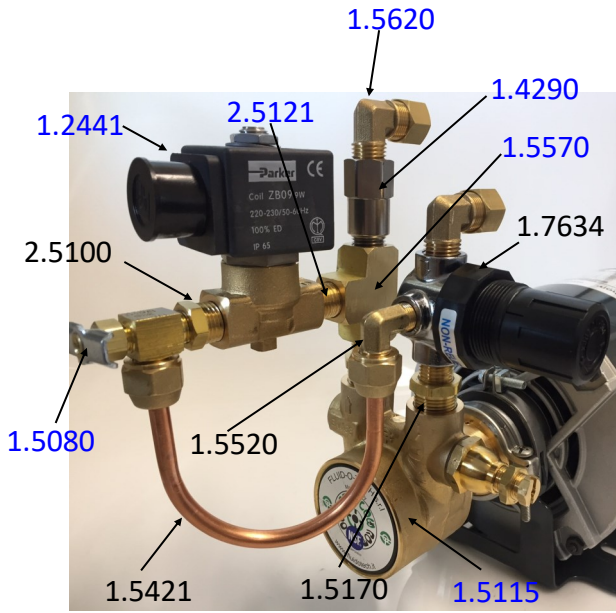

1.7654– Bypass Pump Assembly, (Does NOT include the Motor or By-Pass Box)

- 1.2441 - Water Control Valve
- 1.4290 - Check Valve
- 1.5080 - Brass Mix Valve Fitting
- 1.5115 - Pump and Clamp
- 1.5170 - Fitting, Bushing M Pipe 3/8" x F Pipe 1/4"
- 1.5421 - Copper Tube, 160 mm Long
- 1.5520 - Fitting, Elbow, 1/8" NPT x 1/4" SAE Male
- 1.5570 - Fitting, Tee, 1/4" NPT Female
- 1.5620 - Fitting, Elbow, 1/4" MPT x 3/8" Comp
- 1.7634 - Pressure Regulator
- 2.5121 - Fitting, Close Nipple, SS, 1/4"
- 2.5100 - Fitting, Reducing Bushing, 1/8" to 1/4"

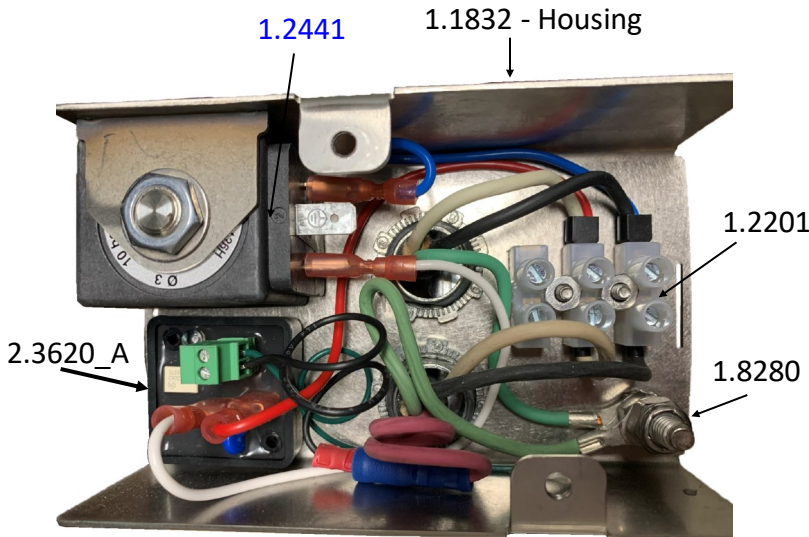

Parts of the By-Pass Box

- 1.1832 - Bypass Housing Base
- 1.1833 - Bypass Housing Cover
- 1.2201 - Terminal Strip, 3 Position
- 1.2320 - Strain Reliefs, 3/8" Metal
- 1.8050 - Screws, 10-32 Truss Hd Slot 1/4"
- 1.8280 - Nut, Nylock, 1/4-20
- 2.3609 - Bypass Solenoid Switch with Wires

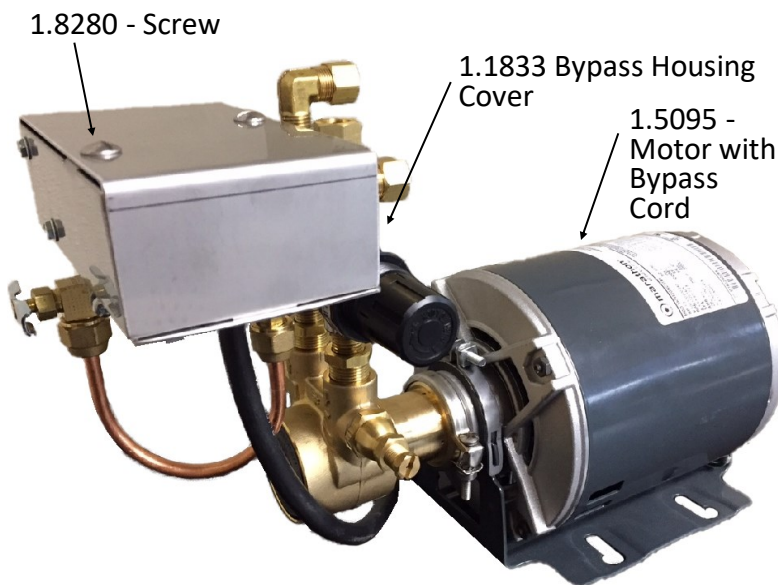

1.7650 - MVP Hydra Bypass Assembly Complete, shown without SS Hoses *from Serial Number xxxx3913

1.7650 Includes:

- 1.7654 - Bypass Pump Assembly
- 1.5095 - Motor with Bypass Cord
- Complete Bypass Box
- Cords

Pump & Motors

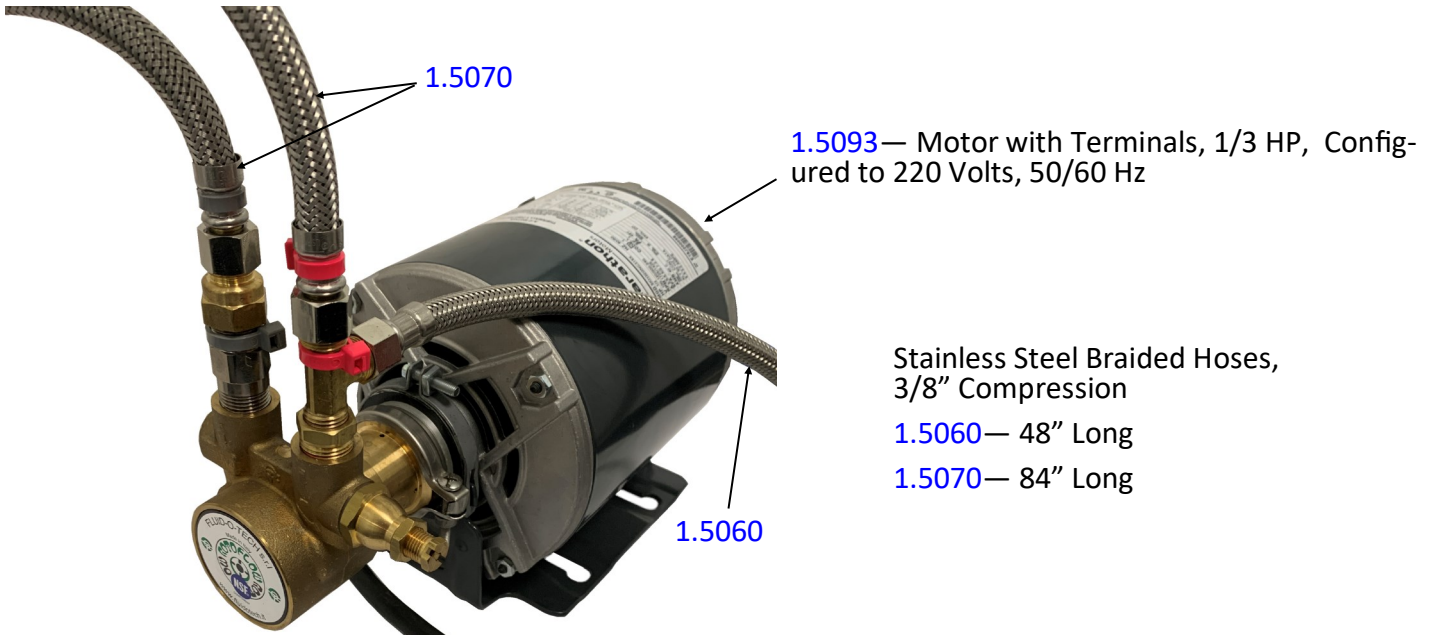

Pump Configurations

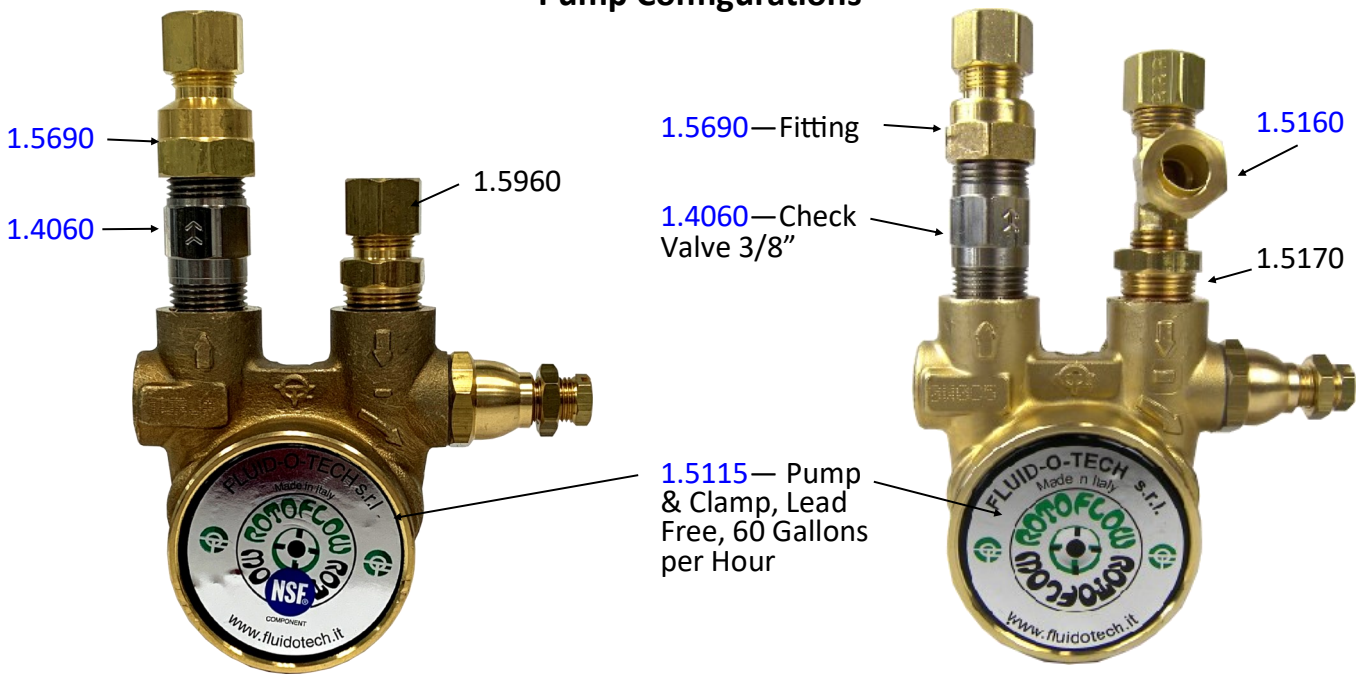

1.5112—Single Inlet Pump, For Line Boost Systems and Early Hydras

1.5111 - Dual Inlet Pump for Single Pump Machines

Line Boost System *Not Shown

1.7878 - Line Boost, MVP Hydra 1,2 or 3 Group when ordered with a new Machine Build

1.7879_L - Line Boost w/ Mini Pressure Regulator, MVP & S Series, Single Pump

1.7875_1, 1.7875_2H, 1.7875_3H - Line Boost for single pump, 2 pump, and 3 pump machines, only for machines from before serial number xxxxx4080.

Portafilters & Baskets

1.7130 - Portafilter w/Synesso Black Handle.
NO Spring or Basket Included



1.7133 - Bottomless Portafilter—NO Spring or Basket Included



1.7132 - Double Spouted Portafilter. NO Spring or Basket Included

1.7131 - Single Spouted Portafilter. NO Spring or Basket (Not Pictured)



1.7041 - Double Spout

1.7050 - Single Spout

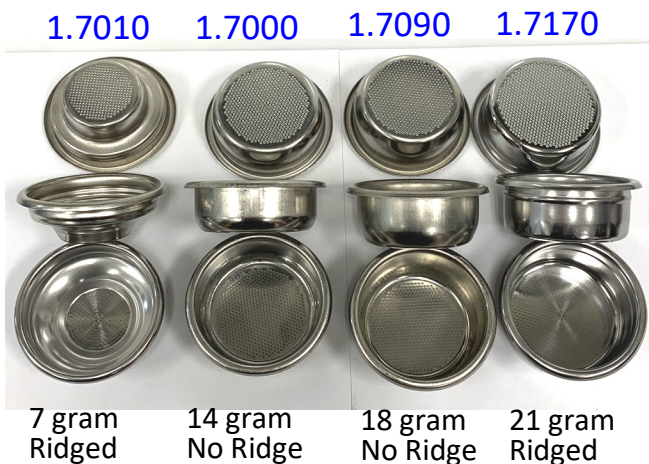

Filter Baskets, 58 mm

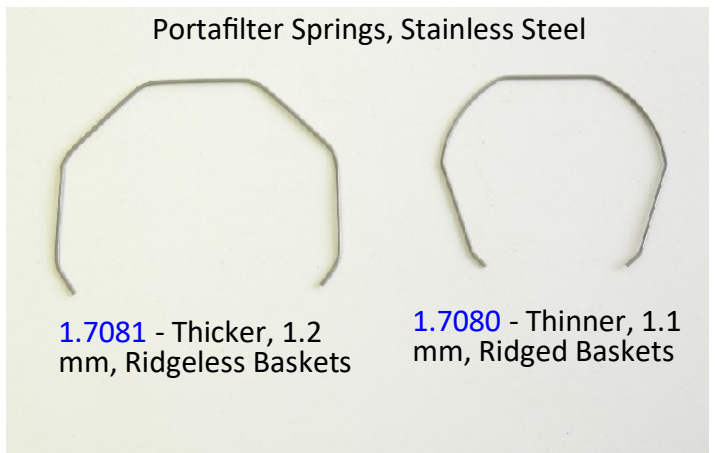

Portafilter Springs, Stainless Steel

1.7081 - Thicker, 1.2 mm, Ridged Baskets

1.7080 - Thinner, 1.1 mm, Ridged Baskets

Parts & Kits

1.3300 - Diffuser Screw, Stainless Steel

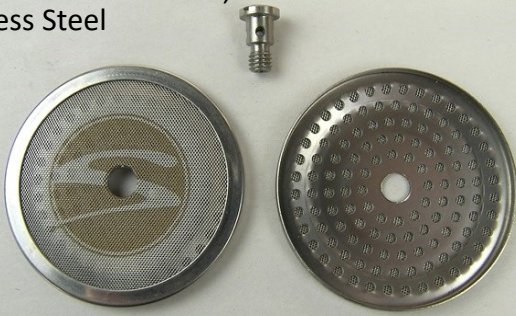

1.3292 - Diffuser Screen, Synesso Logo, Custom, Special Reinforced Screen



1.3431
9 mm



1.3441
8.5 mm

Portafilter Gaskets with Grooved Outside Edges for Easy Installation & Venting of Trapped Water and Air

1.7020 - Back Flush (Blind) Filter Basket



Annual Preventative Maintenance Kits



Our PM kits include all parts needed to perform the annual PM for 2 and 3 group machines

1.7322—2 Group PM Kit

1.7323—3 Group PM Kit

1.7334—2 Group PM Kit with CE Certified Safety Valve

1.7335—3 Group PM Kit with CE Certified Safety Valve

Parts & Kits Continued



1.7320—Steam Valve Rebuilt Kit

1.4505—Steam Valve Seal Holder, Brass

1.4200—Seal for Seat

1.4122—O-Ring, Valve Body @ Hex Nut

1.4123—O-Ring, Wand Nut

*1.4310— O-Ring, Stainless Spool

*1.4321—O-Ring, Wand Ball

*1.4181—O-Rings, Valve Stem

*Use Food Grade Lubricant when Assembling, we recommend Super Lube, Part # 1.8600

Descaling Powder, Primary ingredient is Citric Acid. It is Non-Toxic, Biodegradable, Fast and Effective.

Always Use Proper Precautions.



1.7601 - Dezcal, 7 oz., Activated Scale Remover,

Food Grade Synthetic Grease



1.8600 - Super Lube, 3 oz. Tube

Permanent Strength, Releases with Heat
Always Use Proper Precautions.



1.8630 - 0.2 oz. Tube of Thread Sealant

Wood Packages

Due to the Organic Nature of Wood, Color and Grain will Vary

Portafilters can be configured as: Bottomless (Naked), Double or Single Spouted.

*Spring, basket, and spout sold separately.



Jatoba Wood



Maple



Black Walnut



Zebra Wood

Wood Packages

Part #	Description
2.7170_1	Wood Package MVP Series, Maple, 1 Grp. Machine - 1 Steam Handle, 1 Grp Top Handle & 2 Portafilters
2.7170_2	Wood Package MVP Series, Maple, 2 Grp. Machine - 2 Steam Handles, 2 Grp Top Handles & 3 Portafilters
2.7170_3	Wood Package MVP Series, Maple, 3 Grp. Machine - 2 Steam Handles, 3 Grp Top Handles & 4 Portafilters
2.7130	Wood, Maple, MVP Group Top Handle
2.7135	Wood, Maple, Portafilter Handle Only, No Filter Head
2.7136	Wood, Maple, Steam Actuator Handle Only
2.7138	Wood, Maple, Portafilter Handle & PF Head (Spring, Spout & Basket Sold Separately)
2.7139	Wood, Maple, Steam Actuator Handle with Hanger Bolt
2.7180_1	Wood Package MVP Series, Black Walnut, 1 Grp. Machine - 1 Steam Handle, 1 Grp Top Handle & 2 Portafilters
2.7180_2	Wood Package MVP Series, Black Walnut, 2 Grp. Machine - 2 Steam Handles, 2 Grp Top Handles & 3 Portafilters
2.7180_3	Wood Package MVP Series, Black Walnut, 3 Grp. Machine - 2 Steam Handles, 3 Grp Top Handles & 4 Portafilters
2.7140	Wood, Black Walnut, MVP Group Top Handle
2.7145	Wood, Black Walnut, Portafilter Handle Only, No Filter Head
2.7146	Wood, Black Walnut, Steam Actuator Handle Only
2.7148	Wood, Black Walnut, Portafilter Handle & PF Head (Spring, Spout & Basket Sold Separately)
2.7149	Wood, Black Walnut, Steam Actuator Handle with Hanger Bolt
2.7190_1	Wood Package MVP Series, Zebra, 1 Grp. Machine - 1 Steam Handle, 1 Grp Top Handle & 2 Portafilters
2.7190_2	Wood Package MVP Series, Zebra, 2 Grp. Machine- 2 Steam Handles, 2 Grp Top Handles & 3 Portafilters
2.7190_3	Wood Package MVP Series, Zebra, 3 Grp. Machine - 2 Steam Handles, 3 Grp Top Handles & 4 Portafilters
2.7150	Wood, Zebra, MVP Group Top Handle
2.7155	Wood, Zebra, Portafilter Handle Only, No Filter Head
2.7156	Wood, Zebra, Steam Actuator Handle Only
2.7158	Wood, Zebra, Portafilter Handle & PF Head (Spring, Spout & Basket Sold Separately)
2.7159	Wood, Zebra, Steam Actuator Handle with Hanger Bolt
2.7162_1	Wood Package MVP Series, Jatoba , 1 Grp. Machine - 1 Steam Handle, 1 Grp Top Handle & 2 Portafilters
2.7162_2	Wood Package MVP Series, Jatoba, 2 Grp. Machine - 2 Steam Handles,, 2 Grp Top Handles & 3 Portafilters
2.7162_3	Wood Package MVP Series, Jatoba, 3 Grp. Machine - 2 Steam Handles, 3 Grp Top Handles & 4 Portafilters
2.7110	Wood, Jatoba, MVP Group Top Handle
2.7112	Wood, Jatoba, Portafilter Handle Only, No Filter Head
2.7113	Wood, Jatoba, Steam Actuator Handle Only
2.7118	Wood, Jatoba, Portafilter Handle & PF Head (Spring, Spout & Basket Sold Separately)
2.7119	Wood, Jatoba, Steam Actuator Handle with Hanger Bolt

Options & Accessories

1.1550 - Cup Riser, Stainless Steel

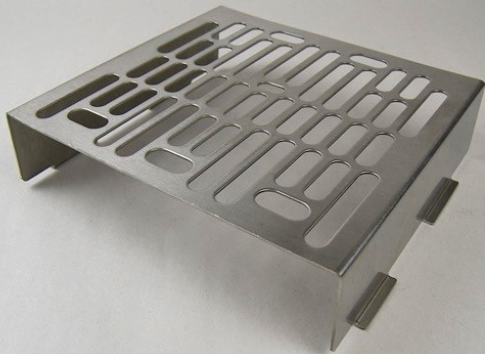

Height 1.5" (38 mm)

Works with Punch Slotted Drip Trays

1.1555 - Shot Mirror for Drip Tray, Polished Stainless Steel



Front Facing View



Side View



1.7771 - Synesso Shot Glass, White Logo, 3 oz., Single Glass

1.7781 - Synesso Shot Glass, White Logo, 3 oz., 6 Pack of Glasses

3.2011 Breaker Blocker Kit



3.2011 - Breaker Blocker Kit for Electrical Box

Easy to Install. Helps to Protect Against Inadvertently Switching the Element Breaker to the Off Position



Trim Kit for Synesso Espresso Machines

Trim Kit Assemblies:

- 2.7581 - 1 Group
- 2.7582 - 2 Group
- 2.7583 - 3 Group
- 2.7584 - 4 Group