



WELLS MANUFACTURING
10 Sunnen Dr., St. Louis, MO 63143
telephone: 314-678-6314
fax: 314-781-2714
www.wellsbloomfield.com

OPERATIONS MANUAL

DROP-IN HOT AND COLD PANS:

- HRCP-7100
- HRCP-7200
- HRCP-7300
- HRCP-7400
- HRCP-7500
- HRCP-7600

AND DROP-IN HOT AND COLD PANS WITH SLOPED TOPS:

- HRCP-7100ST
- HRCP-7200ST
- HRCP-7300ST
- HRCP-7400ST
- HRCP-7500ST
- HRCP-7600ST



Model HRCP-7200

**INCLUDES:
INSTALLATION, USE &
CARE, SERVICE AND
WIRING DIAGRAMS**

IMPORTANT: DO NOT DISCARD THIS MANUAL

This manual is considered to be part of the appliance and is to be given to the OWNER or MANAGER of the restaurant, or to the person responsible for TRAINING OPERATORS of this appliance. Additional manuals are available from your WELLS DEALER.

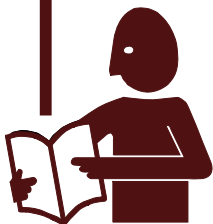

THIS MANUAL MUST BE READ AND UNDERSTOOD BY ALL PERSONS USING OR INSTALLING THIS APPLIANCE. Contact your WELLS DEALER if you have any questions concerning installation, operation or maintenance of this equipment.

LIMITED WARRANTY STATEMENT

Unless otherwise specified, all commercial cooking equipment manufactured by WELLS MANUFACTURING is warranted against defects in materials and workmanship for a period of one year from the date of original installation or 18 months from the date of shipment from our factory, whichever comes first, and is for the benefit of the original purchaser only.

THIS WARRANTY IS THE COMPLETE AND ONLY WARRANTY, EXPRESSED OR IMPLIED IN LAW OR IN FACT, INCLUDING BUT NOT LIMITED TO, WARRANTIES OF MERCHANTABILITY OR FITNESS FOR ANY PARTICULAR PURPOSE, AND/OR FOR DIRECT, INDIRECT OR CONSEQUENTIAL DAMAGES IN CONNECTION WITH WELLS BLOOMFIELD PRODUCTS. This warranty is void if it is determined that, upon inspection by an authorized service agency, the equipment has been modified, misused, misapplied, improperly installed, or damaged in transit or by fire, flood or act of God. It also does not apply if the serial nameplate has been removed, or if service is performed by unauthorized personnel. The prices charged by Wells Manufacturing for its products are

based upon the limitations in this warranty. Seller's obligation under this warranty is limited to the repair of defects without charge by a Wells Manufacturing factory authorized service agency or one of its sub-service agencies. This service will be provided on customer's premises for non-portable models. Portable models (a device with a cord and plug) must be taken or shipped to the closest authorized service agency, transportation charges prepaid, for service. In addition to restrictions contained in this warranty, specific limitations are shown in the Service Policy and Procedure Guide. Wells Manufacturing authorized service agencies are located in principal cities. This warranty is valid in the United States and Canada and void elsewhere. Please consult your classified telephone directory, your foodservice equipment dealer or contact:

Wells Manufacturing
10 Sunnen Dr., St. Louis MO 63143 USA
phone (314) 678-6314 or fax (314) 781-2714

for information and other details concerning warranty.

SERVICE POLICY, PROCEDURE GUIDE and ADDITIONAL WARRANTY EXCLUSIONS

1. Resetting of safety thermostats, circuit breakers, over load protectors, and/or fuse replacements are **not** covered by this warranty unless warranted conditions are the cause.
2. All problems due to operation at **voltages or phase other than specified on equipment nameplates** are **not** covered by this warranty. Conversion to correct voltage and/or phase must be the customer's responsibility.
3. All problems due to **electrical connections not made in accordance with electrical code requirements and wiring diagrams** supplied with the equipment are **not** covered by this warranty.
4. Replacement of items **subject to normal wear**, to include such items as knobs, light bulbs; and, normal maintenance functions including adjustments of thermostats, adjustment of micro switches and replacement of fuses and indicating lights are **not** covered by warranty.
5. Damage to electrical cords and/or plug due to exposure to excessive heat are **not** covered by this warranty.
6. Full use, care, and maintenance instructions supplied with each machine. Noted maintenance and preventative maintenance items, such as servicing and cleaning schedules, are customer responsibility. Those miscellaneous adjustments noted are customer responsibility. Proper attention to preventative maintenance and scheduled maintenance procedures will prolong the life of the appliance.
7. Travel mileage is limited to **sixty (60) miles** from an Authorized Service Agency or one of its sub-service agencies.
8. All labor shall be performed during regular working hours. Overtime premium will be charged to the buyer.
9. All genuine Wells replacement parts are warranted for ninety (90) days from date of purchase on non-warranty equipment. This parts warranty is limited only to replacement of the defective part(s). **Any use of non-genuine Wells parts completely voids any warranty.**
10. Installation, labor, and job check-outs are **not** considered warranty and are thus **not** covered by this warranty.
11. Charges incurred by delays, waiting time or operating restrictions that hinder the service technician's ability to perform service are **not** covered by warranty. This includes institutional and correctional facilities.

SHIPPING DAMAGE CLAIM PROCEDURE

NOTE: For your protection, please note that equipment in this shipment was carefully inspected and packaged by skilled personnel before leaving the factory. Upon acceptance of this shipment, the transportation company assumes full responsibility for its safe delivery.

IF SHIPMENT ARRIVES DAMAGED:

1. **VISIBLE LOSS OR DAMAGE:** Be certain that any visible loss or damage is noted on the freight bill or express receipt, and that the note of loss or damage is signed by the delivery person.
2. **FILE CLAIM FOR DAMAGE IMMEDIATELY:** Regardless of the extent of the damage.

3. **CONCEALED LOSS OR DAMAGE:** if damage is unnoticed until the merchandise is unpacked, notify the transportation company or carrier immediately, and file "CONCEALED DAMAGE" claim with them. This should be done within fifteen (15) days from the date the delivery was made to you. Be sure to retain the container for inspection.

Wells Manufacturing cannot assume liability for damage or loss incurred in transit. We will, however, at your request, supply you with the necessary documents to support your claim.

TABLE OF CONTENTS

WARRANTY , SHIPPING DAMAGE PROCEDURE.....	xi
INTRODUCTION & SPECIFICATIONS	1
FEATURES & OPERATING CONTROLS	2
PRECAUTIONS & GENERAL INFORMATION	3
AGENCY LISTING INFORMATION	4
INSTALLATION	5, 6, 7
OPERATION	8, 9
CLEANING INSTRUCTIONS	10
TROUBLESHOOTING SUGGESTIONS	11
MAINTENANCE INSTRUCTIONS	12, 13, 14
WIRING & REFRIG. DIAGRAM.....	15
BLANK PAGE FOR NOTES.....	16
ACCESSORY PARTS & SERVICE	17
CUSTOMER SERVICE DATA	17

INTRODUCTION

Thank you for purchasing this Wells Manufacturing appliance.

Proper installation, professional operation and consistent maintenance of this appliance will ensure that it gives you the very best performance and a long, economical service life.

This manual contains the information needed to properly install, use and care for this appliance t in a manner which will guarantee its optimum performance.

ELECTRICAL & REFRIGERATION SPECIFICATIONS

WARMER				REFRIGERATION				
MODEL	VOLTS	KW	1ø AMPS	HP	VOLTS	1ø AMPS	REFRIGERANT	POWER SUPPLY REQUIREMENT
HRCP-7100 HRCP-7100ST	208/240 60Hz	1.9/2.5	9.1/10.4	1/4	120 60Hz	4.9	R-134a	3-wire: L1, L2, N #10 AWG min. 60°C
HRCP-7200 HRCP-7200ST	208/240 60Hz	1.9/2.5	9.1/10.4	1/4	120 60Hz	4.9	R-134a	3-wire: L1, L2, N #10 AWG min. 60°C
HRCP-7300 HRCP-7300ST	208/240 60Hz	3.0/4.0	14.4/16.6	1/3	120 60Hz	5.6	R-404a	3-wire: L1, L2, N #10 AWG min. 60°C
HRCP-7400 HRCP-7400ST	208/240 60Hz	3.8/5.0	18.3/20.8	1/2	120 60Hz	8.9	R-404a	3-wire: L1, L2, N #10 AWG min. 60°C
HRCP-7500 HRCP-7500ST	208/240 60Hz	6.0/8.0	28.9/33.3	3/4	120 60Hz	15.2	R-404a	3-wire: L1, L2, N #8 AWG min. 60°C
HRCP-7600 HRCP-7600ST	208/240 60Hz	6.0/8.0	28.9/33.3	3/4	120 60Hz	15.3	R-404a	3-wire: L1, L2, N #8 AWG min. 60°C

NOTE: For equipment and cut-out dimensions, refer to the *Installation Instructions* provided with each unit.

FEATURES & OPERATING CONTROLS

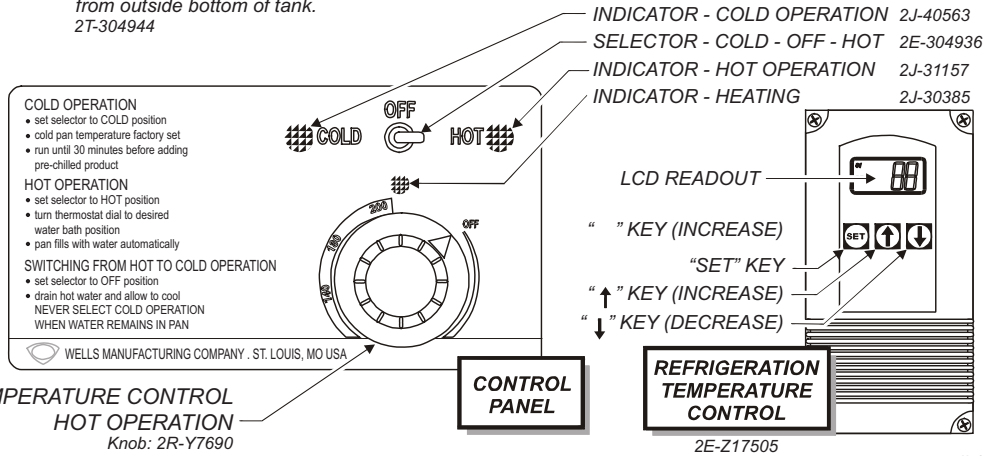
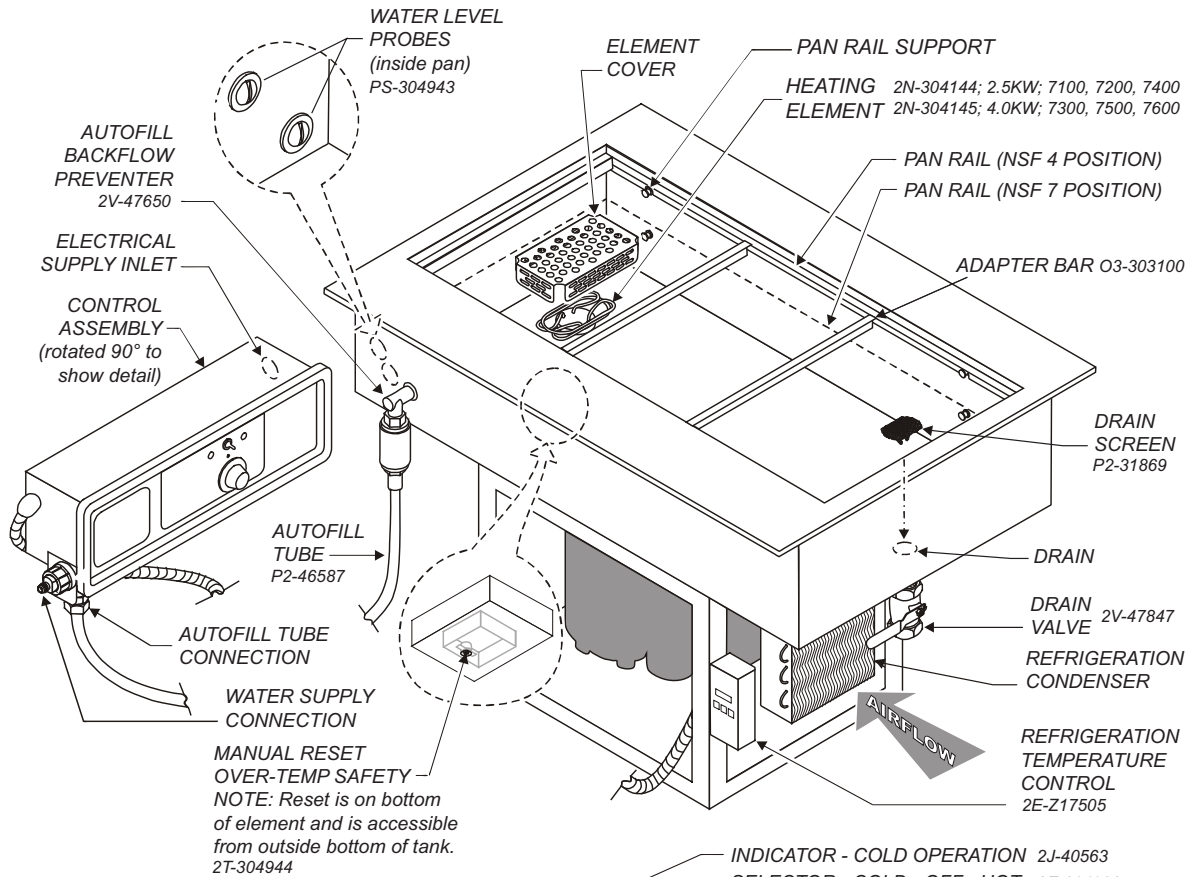

Thermal Control, 36" Capillary: 2T-304937
Thermal Control, 48" Capillary: 2T-304937A

IL2693b

NOTE: Model HRCP-7300 shown. Models in series HRCP-ST slope tops are similar.

Parts Not Shown:

- 2E-302789 CONTACTOR 50A 3 PHASE 208
- 2E-Z17956 SOLENOID VALVE 1/4NPT 240
- 2E-304938 CONTROL WATER LEVEL HRCP
- 2E-305479 FUSE CLASS T TYPE JJS 15A
- 2E-37465 TERM BLOCK 3POLE 85AMP
- 2E-70889 RELAY 30AMP 120V
- WS-23316 PAN RAIL FOR HRCP-7400

M406 p/n 2M-304942 Owners Manual HRCP-Series Heated Cold Pans

PRECAUTIONS AND GENERAL INFORMATION

This appliance is intended for use in commercial establishments only, and is intended to hold previously prepared food for human consumption. Food may be held either hot or cold. No other use is recommended or authorized by the manufacturer or its agents.

Operators of this appliance must be familiar with the appliance use, limitations and associated restrictions. Operating instructions must be read and understood by all persons using or installing this appliance.

For hot operation, the appropriate water level must be maintained at all times. Food must be kept in appropriate inserts. Never place food directly into the tank.

Cleanliness of this appliance is essential to good sanitation. Read and follow all included cleaning instructions and schedules to ensure the safety of the food product.

Disconnect this appliance from electrical power before performing any maintenance or servicing.

DO NOT submerge this appliance in water. This appliance is not jet stream approved. Do not direct water jet or steam jet at this appliance, or at any control panel or wiring. Do not splash or pour water on, in or over any controls, control panel or wiring. Do not wash floor around this appliance with water or steam jet.

Do not operate this appliance if the control panel is damaged. Call your Authorized Wells Service Agent for service.

The technical content of this manual, including any wiring diagrams, schematics, parts breakdown illustrations and/or adjustment procedures, is intended for use by qualified technical personnel.

Any procedure which requires the use of tools must be performed by a qualified technician.

This manual is considered to be a permanent part of the appliance. This manual and all supplied instructions, diagrams, schematics, parts breakdown illustrations, notices and labels must remain with the appliance if it is sold or moved to another location.

This appliance is made in the USA. Unless otherwise noted, this appliance uses all American-sized hardware.



WARNING: ELECTRIC SHOCK HAZARD

All servicing requiring access to non-insulated electrical components must be performed by a factory authorized technician. DO NOT open any access panel which requires the use of tools. Failure to follow this warning can result in severe electrical shock.



CAUTION: RISK OF DAMAGE

DO NOT connect or energize this appliance until all installation instructions are read and followed. Damage to the appliance will result if these instructions are not followed.



CAUTION: HOT SURFACE

Exposed surfaces can be hot to the touch and may cause burns.

AGENCY LISTING INFORMATION



STD 4
STD 7

This appliance is performance tested to NSF Standard 4 for holding hot foods. This appliance conforms to NSF Standard 4 for sanitation only if installed in accordance with the supplied *Installation Instructions* and maintained according to the instructions in this manual.



This appliance performance tested to NSF Standard 7 for storage of potentially hazardous foods. This appliance meets NSF Standard 7 only when the pan rails are installed in the lowest position.



UL197
UL471

HRCP units are ETL listed for US and Canada

HRCP units are evaluated to UL standards 197 and 471.



Components used in the manufacture of this unit are Underwriters Laboratory recognized.

UNPACKING & INSPECTION

Carefully remove the appliance from the carton. Remove all protective plastic film, packing materials and accessories from the Appliance before connecting electrical power or otherwise performing any installation procedure.

Carefully read all instructions in this manual and the *Installation Instruction Sheet* packed with the appliance before starting any installation.

Read and understand all labels and diagrams attached to the appliance.

Carefully account for all components and accessories before discarding packing materials. Store all accessories in a convenient place for later use.

COMPONENTS

- 2 ea. PAN RAIL, LONG SIDES
- 2 ea. PAN RAILS, ENDS
- 1 - 5 ea. PAN RAILS, INTERMEDIATE (qt'y differs with unit)
- 1 ea. BACKFLOW PREVENTER ASSEMBLY
- 1 ea. DRAIN VALVE
- 1 ea. DRAIN SCREEN

PREPARATION

Cutout dimensions for tank units and control panels are listed on the *Installation Instructions* provided with the unit.

Countertop must be flat and level before the unit is installed. After cutout is made, add stiffeners or bottom braces to counter as required to support unit weight.

Provide louvered grills and service access below control panel.

Verify that provided sealants are applied to the underside of the top flange prior to setting the unit into the cutout.

After installation, apply a thin bead of food-grade silicone sealant around the flange to seal it to the counter.

IMPORTANT:

Unit flange must be sealed to the counter top. Damage caused by leaks due to improper installation is NOT covered by warranty.

For installation in plastic (e.g. Corian®) or stone counter tops, the counter material must be protected from the heat of the warmer in order to prevent discoloration, deterioration or cracking. The installer should contact the manufacturer or distributor of the countertop material for specific installation instructions.

Avoid storing flammable or combustible materials in, on or near the appliance.

NOTE: DO NOT discard the carton or other packing materials until you have inspected the appliance for hidden damage and tested it for proper operation. Refer to *SHIPPING DAMAGE CLAIM PROCEDURE* on the inside front cover of this manual.



WARNING: RISK OF INJURY

Installation procedures must be performed by a qualified technician with full knowledge of all applicable electrical and plumbing codes. Failure can result in personal injury and property damage.

IMPORTANT:

Unit must remain in an upright position during installation to prevent damage to the refrigeration system.

IMPORTANT:

Refrigeration system is air cooled. Recommend louvered grills or equivalent openings on left and right side of condensing unit, with a minimum size of twice the condenser area (each opening) in order to provide adequate air circulation.

IMPORTANT:

DO NOT block air openings. Damage to the compressor will result. Damage caused by improper air circulation is NOT covered by warranty.

IMPORTANT:

Access is required for the operation of the drain valve and for maintenance of the refrigeration unit. Provide adequate access to the drain valve and refrigeration unit.

INSTALLATION



WARNING: **ELECTRIC** **SHOCK HAZARD**

All servicing requiring access to non-insulated electrical components must be performed by a factory authorized technician.

DO NOT open any access panel which requires the use of tools. Failure to follow this warning can result in severe electrical shock.



CAUTION: **RISK OF** **DAMAGE**

DO NOT connect or energize this appliance until all installation instructions are read and followed. Damage to the appliance will result if these instructions are not followed.



CAUTION: **ELECTRICAL** **SHOCK HAZARD**

The ground lug of this appliance must be connected to a suitable building ground.

IMPORTANT:

Contact a licensed electrician to install and connect electrical power to the appliance.

IMPORTANT:

Damage due to being connected to the wrong voltage or phase is NOT covered by warranty.

ELECTRICAL INSTALLATION

1. Refer to the nameplate. Verify the electrical service power. Voltage and phase must match the nameplate specifications. Wiring the unit to the wrong voltage can severely damage the unit or cause noticeably decreased performance.
2. Available electrical service amperage must meet or exceed the specifications listed on the specification sheet provided with the unit. Connect to the terminal block in the control unit. Wiring must be secured to the control unit with an appropriate strain relief (provided by installer).

IMPORTANT:

- * L1 to L2 must be 208 to 240 volts AC.
- * L2 to Neutral must be 120 volts AC

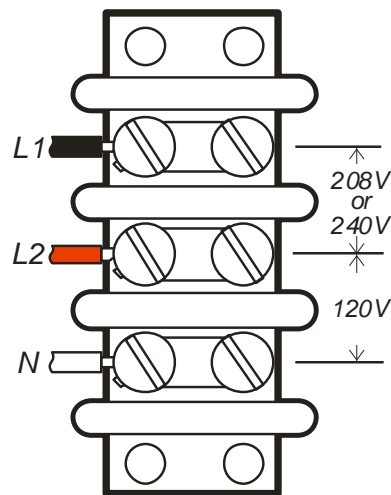

3. Tank and control unit must be connected to an appropriate building ground. Ground connection will be marked "GND" or "GND".

NOTE: Wire gauge, insulation type and temperature rating, as well as type, size and construction of conduit, must meet or exceed applicable specifications of local codes and of the National Electrical Code.

PLUMBING INSTALLATION

1. Install provided 1" drain valve on unit drain. Plumb to an appropriate waste as required by local plumbing and sanitation ordinances.

IMPORTANT:

DO NOT allow the sink drain spud to turn during installation. Hold the spud with an appropriate cross-guard-style spud wrench, or carefully grip the center threaded portion with a strap wrench or slip-joint pliers to immobilize the drain spud during drain fitting installation.

DO NOT grip the drain spud nut or gasket.

2. Install provided backflow preventer assembly to the tank water inlet. Attach water outlet tubing from water connection (located on bottom left of control unit) to the inlet of the backflow preventer.

NOTE: While a backflow preventer is incorporated into the unit, local codes may require an additional backflow preventer or vacuum breaker in the water inlet line.

3. The unit must be connected to a potable cold water supply line with average pressure between 20 PSI and 90 PSI. If your water pressure exceeds 90 PSI at anytime, a pressure regulator must be installed in the water supply line to limit the pressure to not more than 90 PSI in order to avoid damage to lines and solenoid. Install water supply to inlet fitting (located on left side of control unit) with a 1/4" female flare.
4. A water shut-off valve should be installed on the incoming water line in a convenient location (Use a low restriction type valve, such as a 1/4-turn ball valve, to avoid loss of water flow thru the valve).
5. Test the operation of the auto fill in the HOT operation mode.

IMPORTANT:

Plumbing connections must be made in compliance with all Federal, State and Local Codes and Ordinances.

IMPORTANT:

All drain plumbing installations must be performed by a qualified plumber.

NOTE:

All water line connections are made *OUTSIDE* of the control unit.

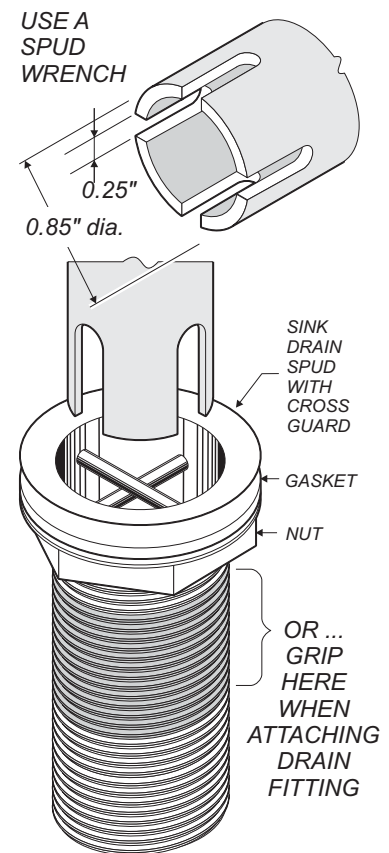

OPERATION



CAUTION: HOT SURFACE

Exposed surfaces can be hot to the touch and may cause burns.



CAUTION: ELECTRICAL SHOCK HAZARD

DO NOT splash or pour water onto control panel or wiring.



CAUTION: EQUIPMENT DAMAGE

DO NOT operate the unit without the element cover in place. Operation without the element cover will allow damage to the temperature sensing element.

HRCP units are performance tested to NSF Standard 4 for holding hot foods.

Always drain unit and allow to cool before switching to COLD operation.

HOT OPERATION

COLD OPERATION

- set selector to **COLD** position
- cold pan temperature factory set
- run until 30 minutes before adding pre-chilled product

HOT OPERATION

- set selector to **HOT** position
- turn thermostat dial to desired water bath position
- pan fills with water automatically

SWITCHING FROM HOT TO COLD OPERATION

- set selector to **OFF** position
- drain hot water and allow to cool
- NEVER SELECT COLD OPERATION WHEN WATER REMAINS IN PAN**

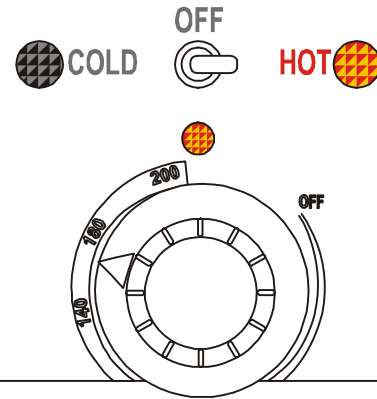

WELLS MANUFACTURING COMPANY . VERDI, NY USA

1. Verify that drain valve is *CLOSED*, the DRAIN SCREEN is in place, and the ELEMENT COVER is properly positioned over the heating element.
2. Turn SELECTOR SWITCH to *HOT*. The red HOT indicator will glow and the tank will begin filling with water.
3. Set the TEMPERATURE CONTROL to the desired temperature. When the water in the tank reaches the minimum water level the heating elements are energized and the water will begin heating. The HEAT indicator will glow while the unit is heating.
 - a. Temperature range is (OFF) - 85°F to 205°F.
 - b. When the HEAT indicator goes out, the water in the tank is up to the set temperature.
4. Install the pan rails.
 - a. Side rails are installed first. For normal hot operation, install the side rails on the upper pan rail supports.
 - b. Install the end rails, then any intermediate rails.
5. Install pans or insets on the pan rails.

IMPORTANT:

Always use a pan or inset. Never place food directly into the tank.

6. Cover pans and insets to maintain consistent temperature. Stir thick foods frequently.

SHUT DOWN PROCEDURE

1. Turn SELECTOR SWITCH to *OFF*. The red HOT indicator will turn off.
2. Remove all pans and insets.
3. Open drain valve.

COLD OPERATION

COLD OPERATION

- set selector to **COLD** position
- cold pan temperature factory set
- run until 30 minutes before adding pre-chilled product

HOT OPERATION

- set selector to **HOT** position
- turn thermostat dial to desired water bath position
- pan fills with water automatically

SWITCHING FROM HOT TO COLD OPERATION

- set selector to **OFF** position
- drain hot water and allow to cool
- NEVER SELECT COLD OPERATION WHEN WATER REMAINS IN PAN**

WELLS MANUFACTURING COMPANY . VERDI, NV USA



**CAUTION:
ELECTRICAL
SHOCK HAZARD**

DO NOT splash or pour water onto control panel or wiring.

HRCP units are performance tested to NSF Standard 4 for holding non-critical foods.

HRCP units are performance tested to NSF Standard 7 for holding potentially hazardous foods only when the pan rails are installed on the **lower** pan rail supports, Ambient room temperature must be 86°F (30°C) or less. Unit maintains pre-chilled foods at 33°F - 41°F.

Tank must be dry for COLD operation. Water in the tank will form ice, compromising the cooling to the food product. Ice in the tank will delay the proper use of the unit when switching to HOT operation.

1. Verify that drain valve is *OPEN*, and the ELEMENT COVER is properly positioned over the heating element. The tank must be dry.
2. Turn SELECTOR SWITCH to *COLD*. The white COLD indicator will glow. When the tank cools to 100°F or less, the refrigeration system will start.
3. The temperature is factory set to NSF 7 required of 33°F - 41°F.
4. Install the pan rails.
 - a. Side rails are installed first.
For normal cold operation, install the side rails on the upper pan rail supports.
For holding potentially hazardous foods, install the side rails on the lower pan rail supports.
 - b. Install the end rails, then any intermediate rails.
5. Install pans or insets on the pan rails.

IMPORTANT:

Always use a pan or inset. Never place food directly into the tank.

IMPORTANT:

For NSF 7 operation, use 12" x 20" x 4" deep pans, and use the lower pan rail supports which are recessed 3" from tank top.

SHUT DOWN PROCEDURE

1. Turn SELECTOR SWITCH to *OFF*. The white COLD indicator will turn off.
2. Remove all pans and insets.

CLEANING INSTRUCTIONS



CAUTION: ELECTRIC SHOCK HAZARD

DO NOT splash or pour water onto control panel or wiring.



CAUTION: EQUIPMENT DAMAGE

DO NOT operate the unit without the element cover in place. Operation without the element cover will allow damage to the temperature sensing element .

IMPORTANT: DO NOT use steel wool for cleaning.

PREPARATIONS: Turn temperature control knob and selector switch to *OFF*. Allow tank to cool before proceeding. Remove any insets, pans and/or adapter tops (if used). Drain water from tank.

FREQUENCY: Daily

TOOLS: Warm Water and Mild Detergent
Solution: 10 Parts Warm Water to 4 Parts Vinegar
Plastic Scouring Pad
Clean Cloth or Sponge
Food-Grade Silicone Sealant

1. Remove pan rails, element cover and drain screen. Wipe interior of tank using a clean cloth or sponge and mild detergent.
2. Use a plastic scouring pad to remove any mineral deposits from water level probes.
3. Rinse tank thoroughly with a vinegar and water solution to neutralize all detergent / cleanser residue.
4. Pan rails and element cover may be washed in a sink or dishwasher. Allow to dry thoroughly, then reinstall.
5. Check drain screen, clean if necessary and reinstall.
6. Periodically inspect warmer flange-to-counter seal. Reseal with food-grade silicone sealant if necessary.
7. Inspect tank and control panel for damage. Contact your Authorized Wells Service Agency for repairs if water or grease contamination is suspected.
8. Inspect cooling louvers in counter. Remove any lint or debris.

Procedure is complete

TROUBLESHOOTING SUGGESTIONS

SYMPTOM	POSSIBLE CAUSE	REMEDY
No power to unit	Circuit breaker tripped	Reset circuit breaker
	Selector switch OFF	Set to HOT or COLD
Unit doesn't heat (HOT Mode)	Selector switch not set to HOT	Set to HOT
	Insufficient water in tank	Be sure drain valve is closed Allow to fill above min water level
	Temp control not set high enough	Set temp control
	Min water level sensor dirty	Clean water level sensors
	Hi-limit safety tripped	Allow to cool, reset hi-limit
	Internal damage	Contact Authorized Wells Service Agency for repairs
Food not kept hot enough (HOT Mode)	Food was not pre-heated	Add only pre-heated food
	Food too thick	Stir thick food frequently
	Temp control not set high enough	Set temp control to desired temp
	One hi-limit tripped (7400, 7500 or 7600 models)	Allow to cool, reset hi-limit
	Internal damage	Contact Authorized Wells Service Agency for repairs
Unit doesn't cool (COLD Mode)	Selector switch not set to COLD	Set to COLD
	Tank too hot	Allow to cool to 100°F or less
	Condenser cooling louvers or coil plugged	Clean condenser louvers and/or coil
	Internal damage	Contact Authorized Wells Service Agency for repairs
Food not kept cold enough (COLD Mode)	Food was not pre-chilled	Add only pre-chilled food
	Pan rails set on high position	For NSF 7 operation use lower pan rail supports
	Condenser cooling louvers or coil plugged	Clean condenser louvers and/or coil
	Refrigerant adjustment needed	Contact Authorized Wells Service Agency for repairs
Tank will not fill	Selector switch not set to HOT	Set to HOT
	Minimum water level sensor dirty	Clean water level sensors
	Drain valve open	Be sure drain valve is closed
	Internal damage	Contact Authorized Wells Service Agency for repairs
Tank overflows	Maximum water level sensor dirty	Clean water level sensors
	Internal damage	Contact Authorized Wells Service Agency for repairs

M406 p/n 2M-304942 Owners Manual HRC-P-Series Heated Cold Pans

MAINTENANCE INSTRUCTIONS



CAUTION: INJURY HAZARD

Disconnect appliance from electrical power before cleaning.

Wells hot and cold pans are constructed of high quality stainless steel. As long as the stainless steel surface is intact, the equipment will not rust or corrode.

Recommendation:

A water softening device or a cartridge-type filtration device may be used to minimize lime and calcium build-up.

CARE OF STAINLESS STEEL

1. The surface can be damaged by mechanical abrasion, hard water deposits and chlorine:
 - a. **NEVER** use steel wool, wire brushes or metal scrapers to clean the appliance. These will damage the surface.
 - b. Hard water deposits left behind when water is evaporated will attack the surface and allow the stainless steel to rust.
 - c. Chlorides from chlorinated cleansers, calcium / lime / rust removers (e.g. muriatic acid), even heavily chlorinated city water will attack the surface and allow the stainless steel to rust.
 - d. **DO NOT** use any highly caustic cleaners. Use of highly caustic cleaners will damage the surface.
 - a. **LIMIT USE** of strong caustic cleaners on warmers. Rinse thoroughly with a vinegar and water solution to neutralize any residue. Failure to do so may cause damage to the surface and allow the stainless steel to rust.
 - e. Cleansers containing ammonia will attack the surface and allow the stainless steel to rust.
2. Use the proper tools in the proper way to clean your Wells warmer:
 - a. Soft cloth and plastic scouring pads are safe to use on stainless steel surfaces.
 - b. Stainless steel pads may be used **ONLY IF** the scrubbing motion is in the direction of the visible grain. **DO NOT** use a circular motion.
 - c. In the absence of visible grain, use only soft cloth or plastic pads. Scrub only in a linear motion along the longest axis of the equipment.
4. Use only non-chloride and non-ammonia cleansers:
 - a. **DO NOT** use any cleanser listed as "chlorinated".
 - b. **DO NOT** use any cleanser listing "ammonia" or "ammonium" in its contents.
 - c. Contact your cleaning materials supplier for suitable alkaline cleansers.
5. Keep your Wells hot and cold pan clean. Clean frequently to avoid build-up of hard, stubborn stains and hard-to-remove deposits:
 - a. Rinse thoroughly with a vinegar and water solution to neutralize any residue.
 - b. For discoloration caused by using the warmer in dry operation, use a cleaner made specifically for stainless steel.
 - c. Wipe dry with a soft, clean, dry cloth.
 - d. Restore the surface by using a polishing product specifically made for stainless steel after each cleaning.
6. In areas where tap water has a high mineral content, warmers may develop lime deposits.

Use a non-chloride de-liming agent to remove lime deposits. It is important to use *Lime and Scale Cleaner for Warmer Pans* often to prevent a difficult-to-remove build-up of lime deposits.

MAINTENANCE INSTRUCTIONS

LIME AND SCALE CLEANER INSTRUCTIONS

Wells Lime and Scale Cleaner for Warmer Pans (instructions modified for used in Hot and Cold Pan)

NOTE: Perform weekly, or whenever lime or scale is seen accumulating on the sides of the tank.

1. Add water to tank until water is at normal operating level or until water covers accumulated scale.
2. Turn SELECTOR SWITCH to HOT. Heat water to maximum temperature (190°F or higher).
3. For models 7100, use one package,
7200 use 2 packages,
7300 use 3 packages,
7400 use 4 packages,
7500 use 5 packages,
7600 use 6 packages.
Pour content of packages into tank. Stir to dissolve cleaner.
Cover tank.
4. Allow solution to soak at least one hour, or overnight for heavy scale buildup.
5. After soak period, turn control to OFF position.
6. Drain hot water from pans.
Scrub with a plastic scouring pad.
Rinse thoroughly with hot water then dry.
7. Refill tank and resume operation.
8. Heavy scale buildup may require additional treatments.



FIRST AID

EYES: In case of contact, immediately flush with warm water for 15 minutes and consult a physician

SKIN: Wash with soap and water

INHALATION: Relocate to fresh air.

INGESTION: If swallowed, drink plenty of water or milk and consult a physician

EMERGENCY PHONE :
(800) 255-3924

IMPORTANT:
Turn selector switch OFF if soaking overnight.

MAINTENANCE INSTRUCTIONS



CAUTION: HOT SURFACE

Exposed surfaces can be hot to the touch and may cause burns.



CAUTION: INJURY HAZARD

Disconnect appliance from electrical power before cleaning condenser coil.



CAUTION: INJURY HAZARD

Condenser coil fins are sharp. Use care to avoid cuts while cleaning the condenser.

CONDENSER COIL CLEANING INSTRUCTIONS

The condenser coil must be kept clean to allow adequate air flow for proper heat dissipation. Recommend this procedure be performed monthly.

1. Turn selector switch to *OFF*. Disconnect appliance from electrical power.
 2. Remove louvers or access panel to allow coil to be reached.
 3. Using a stiff bristle brush, brush lint and debris from the condenser fins. Brush vertically, top to bottom. Collect and discard all lint and debris gathered from this operation
- IMPORTANT:** The fins of the condenser coil are delicate and easily damaged. Use care to brush only in a vertical motion to avoid damaging the coil fins.
4. Wipe the fan blades to remove accumulated lint.
 5. Reconnect to electrical power. Refer to COLD Operation (page 7) and test for proper operation.

WIRING & REFRIGERATION DIAGRAMS

**WIRING DIAGRAM FOR
HRCP-7100 THRU 7600 W/AUTO WATER FILL
120/208-240V, 3 WIRE, SINGLE PHASE**

ELECTRICAL RATING			120/208-240 VAC			60 HZ		
MODEL	WARMER			REFRIGERATION			REFRIGERANT TYPE	
	HRCP NO	VOLTS	KW	AMPS 1-PH L1-L2	VOLTS	HP		
7100	208	1.9	9.0	120	1/4	15	5.5	R-134-A
	240	2.5	10.4					
7200	208	1.9	9.0	120	1/4	15	5.5	R-134-A
	240	2.5	10.4					
7300	208	3.0	14.4	120	1/3	15	7.0	R-404-A
	240	4.0	16.7					
7400	208	3.8	18.1	120	1/2	15	7.5	R-404-A
	240	5.0	20.8					
7500	208	6.0	28.9	120	3/4	30	15.3	R-404-A
	240	8.0	33.3					
7600	208	6.0	28.9	120	3/4	30	15.3	R-404-A
	240	8.0	33.3					

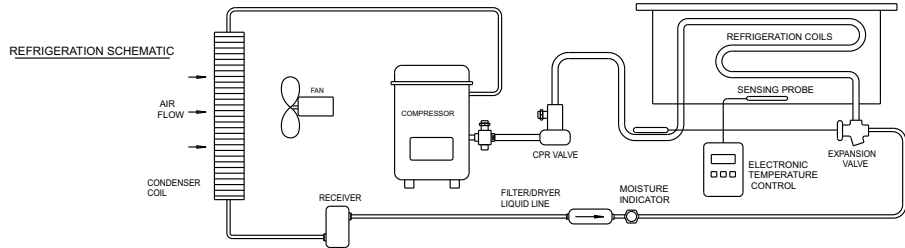
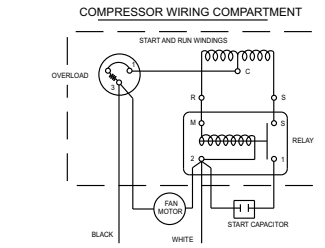
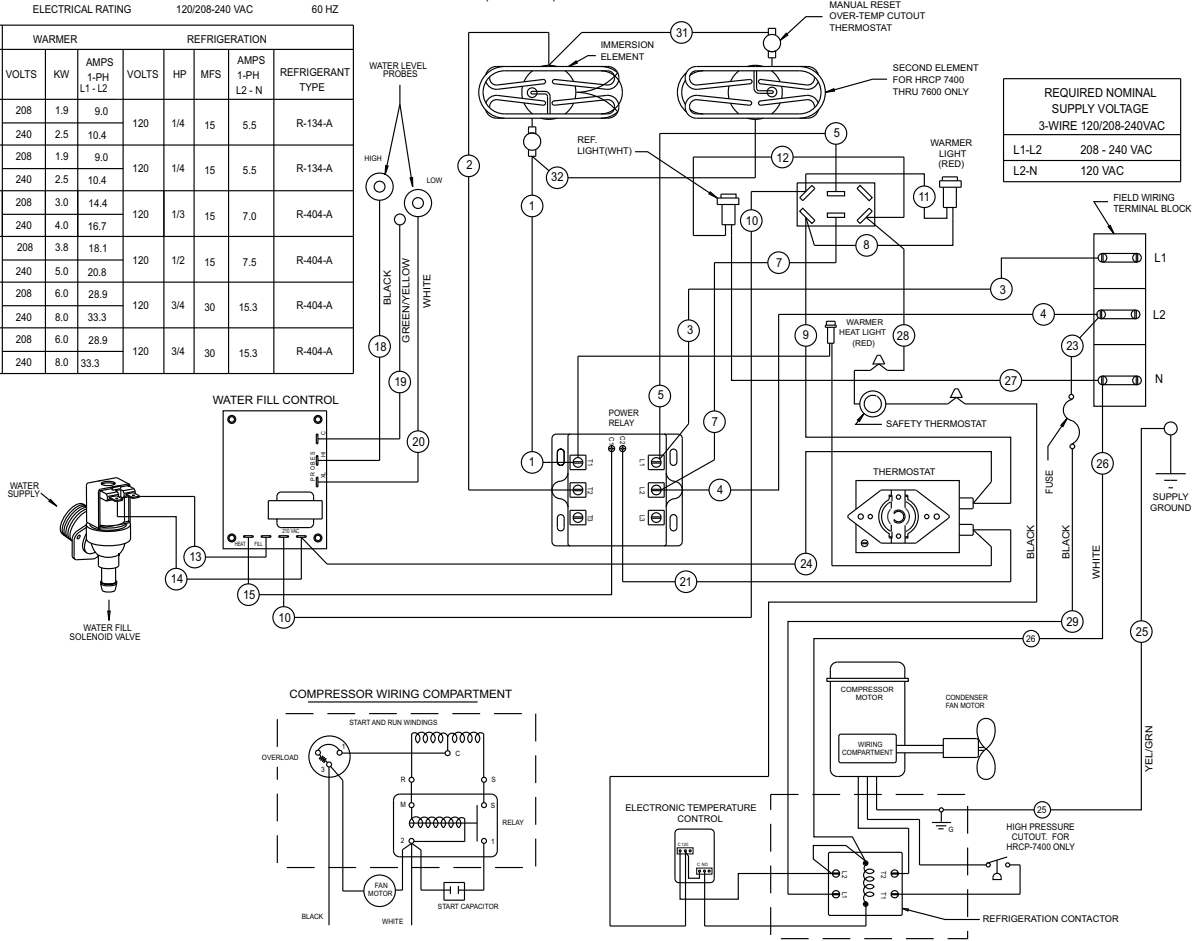

M406 p/n 2M-304942 Owners Manual HRCP-Series Heated Cold Pans

PARTS LIST

ACCESSORY PARTS & SERVICE

DESCRIPTION	PART NO.
DRAIN SCREEN	P2-31869
SOUP LADLE, 6 oz.	DD-47088
ELEMENT HRCP SERIES 2.5kW	2N-304144

IMPORTANT: Use only factory authorized service parts and replacement filters.

For factory authorized service, or to order factory authorized replacement parts, contact your Wells authorized service agency, or call:

Wells Manufacturing

10 Sunnen Dr.
St. Louis MO 63143 USA

Service Dept.

phone: (314) 678-6314
fax: (314) 781-2714

Service Parts Department can supply you with the name and telephone number of the **WELLS AUTHORIZED SERVICE AGENCY** nearest you.

CUSTOMER SERVICE DATA

please have this information available if calling for service

RESTAURANT _____ LOCATION _____
 INSTALLATION DATE _____ TECHNICIAN _____
 SERVICE COMPANY _____
 ADDRESS _____ STATE _____ ZIP _____
 TELEPHONE NUMBER (____) _____ - _____

EQUIPMENT MODEL NO. _____
 EQUIPMENT SERIAL NO. _____
 VOLTAGE: (check one) 208 240



Wells Bloomfield proudly supports CFESA
Commercial Food Equipment Service Association

SERVICE TRAINING - QUALITY SERVICE



CUSTOMER SATISFACTION



WELLS MANUFACTURING
10 Sunnen Dr., St. Louis, MO 63143
telephone: 314-678-6314
fax: 314-781-2714
www.wellsbloomfield.com