



WELLS MANUFACTURING
10 Sunnen Dr., St. Louis, MO 63143
telephone: 314-678-6314
fax: 314-781-2714
www.wellsbloomfield.com

212

OWNERS MANUAL

**ELECTRONIC
CONTROLLED
WAFFLE BAKER**

**MODEL
WB1C
WB2C**

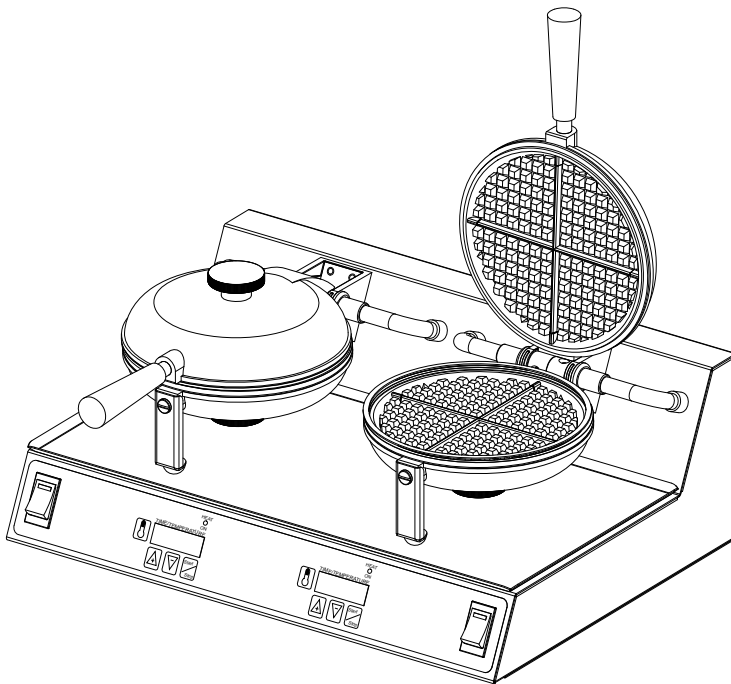

**Manual Includes
INSTALLATION
USE & CARE
EXPLODED VIEW
PARTS LIST
WIRING DIAGRAM**

IMPORTANT: DO NOT DISCARD THIS MANUAL

This manual is considered to be part of the appliance and is to be given to the OWNER or MANAGER of the restaurant, or to the person responsible for TRAINING OPERATORS of this appliance. Additional manuals are available from your WELLS DEALER.

THIS MANUAL MUST BE READ AND UNDERSTOOD BY ALL PERSONS USING OR INSTALLING THIS APPLIANCE. Contact your WELLS DEALER if you have any questions concerning installation, operation or maintenance of this equipment.

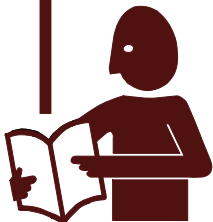

LIMITED WARRANTY STATEMENT

Unless otherwise specified, all commercial cooking equipment manufactured by Wells Manufacturing is warranted against defects in materials and workmanship for a period of one year from the date of original installation or 18 months from the date of shipment from our factory, whichever comes first, and is for the benefit of the original purchaser only.

THIS WARRANTY IS THE COMPLETE AND ONLY WARRANTY, EXPRESSED OR IMPLIED IN LAW OR IN FACT, INCLUDING BUT NOT LIMITED TO, WARRANTIES OF MERCHANTABILITY OR FITNESS FOR ANY PARTICULAR PURPOSE, AND/OR FOR DIRECT, INDIRECT OR CONSEQUENTIAL DAMAGES IN CONNECTION WITH WELLS BLOOMFIELD PRODUCTS. This warranty is void if it is determined that, upon inspection by an authorized service agency, the equipment has been modified, misused, misapplied, improperly installed, or damaged in transit or by fire, flood or act of God. It also does not apply if the serial nameplate has been removed, or if service is performed by unauthorized personnel. The prices

charged by Wells Manufacturing for its products are based upon the limitations in this warranty. Seller's obligation under this warranty is limited to the repair of defects without charge by a Wells Manufacturing factory authorized service agency or one of its sub-service agencies. This service will be provided on customer's premises for non-portable models. Portable models (a device with a cord and plug) must be taken or shipped to the closest authorized service agency, transportation charges prepaid, for service. In addition to restrictions contained in this warranty, specific limitations are shown in the Service Policy and Procedure Guide. Wells Manufacturing authorized service agencies are located in principal cities. This warranty is valid in the United States and Canada and void elsewhere. Please consult your classified telephone directory, your foodservice equipment dealer or contact:

Wells Manufacturing

10 Sunnen Dr., St. Louis MO 63143 USA
phone (314) 678-6314 or fax (314) 781-2714

for information and other details concerning warranty.

SERVICE POLICY AND PROCEDURE GUIDE and ADDITIONAL WARRANTY EXCLUSIONS

1. Resetting of safety thermostats, circuit breakers, over load protectors, and/or fuse replacements are **not** covered by this warranty unless warranted conditions are the cause.
2. All problems due to operation at **voltages or phase other than specified on equipment nameplates** are **not** covered by this warranty. Conversion to correct voltage and/or phase must be the customer's responsibility.
3. All problems due to **electrical connections not made in accordance with electrical code requirements and wiring diagrams** supplied with the equipment are **not** covered by this warranty.
4. Replacement of items **subject to normal wear**, to include such items as knobs, light bulbs; and, normal maintenance functions including adjustments of thermostats, adjustment of micro switches and replacement of fuses and indicating lights are **not** covered by warranty.
5. Damage to electrical cords and/or plug due to exposure to excessive heat are **not** covered by this warranty.
6. Full use, care, and maintenance instructions supplied with each machine. Noted maintenance and preventative maintenance items, such as servicing and cleaning schedules, are customer responsibility. Those miscellaneous adjustments noted are customer responsibility. Proper attention to preventative maintenance and scheduled maintenance procedures will prolong the life of the appliance.
7. Travel mileage is limited to **sixty (60) miles** from an Authorized Service Agency or one of its sub-service agencies.
8. All labor shall be performed during regular working hours. Overtime premium will be charged to the buyer.
9. All genuine Wells replacement parts are warranted for ninety (90) days from date of purchase on non-warranty equipment. This parts warranty is limited only to replacement of the defective part(s). **Any use of non-genuine Wells parts completely voids any warranty.**
10. Installation, labor, and job check-outs are **not** considered warranty and are thus **not** covered by this warranty.
11. Charges incurred by delays, waiting time or operating restrictions that hinder the service technician's ability to perform service are **not** covered by warranty. This includes institutional and correctional facilities.

SHIPPING DAMAGE CLAIM PROCEDURE

NOTE: For your protection, please note that equipment in this shipment was carefully inspected and packaged by skilled personnel before leaving the factory. Upon acceptance of this shipment, the transportation company assumes full responsibility for its safe delivery.

IF SHIPMENT ARRIVES DAMAGED:

1. **VISIBLE LOSS OR DAMAGE:** Be certain that any visible loss or damage is noted on the freight bill or express receipt, and that the note of loss or damage is signed by the delivery person.
2. **FILE CLAIM FOR DAMAGE IMMEDIATELY:** Regardless of the extent of the damage.
3. **CONCEALED LOSS OR DAMAGE:** if damage is unnoticed until the merchandise is unpacked, notify the transportation company or carrier immediately, and file "CONCEALED DAMAGE" claim with them. This should be done within fifteen (15) days from the date the delivery was made to you. Be sure to retain the container for inspection.

Wells Manufacturing cannot assume liability for damage or loss incurred in transit. We will, however, at your request, supply you with the necessary documents to support your

TABLE OF CONTENTS

WARRANTY	xi
ELECTRICAL SPECIFICATIONS	1
FEATURES & OPERATING CONTROLS	2
PRECAUTIONS & GENERAL INFORMATION	3
AGENCY LISTING INFORMATION	3
INSTALLATION	4
Unpacking & Inspection	4
Set-up	4
Seasoning the Grids	4
OPERATION	5
General Operational Notes	5
Operation	5
Cooking Recommendations	5
CLEANING INSTRUCTIONS	6-7
MAINTENANCE	8
TROUBLESHOOTING SUGGESTIONS	8
WIRING DIAGRAM	9-10
WB1C	9
WB1C-208/240V, 220/240V	10
WB2C	11
EXPLODED VIEW & PARTS LIST	12-14
PARTS & SERVICE	17
CUSTOMER SERVICE DATA	17

INTRODUCTION

Thank You for purchasing this Wells Manufacturing appliance.

Proper installation, professional operation and consistent maintenance of this appliance will ensure that it gives you the very best performance and a long, economical service life.

This manual contains information and instructions for the ventless ventilation hood, its use and care.

For information regarding cooking appliance(s), please refer to the manufacturer's operation manual.

ELECTRICAL SPECIFICATIONS

Model	Style	Voltage	Watts	Amps	Power Supply Cord
WB1C	Single Waffle Baker	120V	900	7.5A	NEMA 5-15P
		240V	1800	7.5A	NEMA 6-15P
WB1C-230EU		220/240V	792 / 912	3.6/3.8A	CEE7/VII
WB1C-230UK		220/240V	792 / 912	3.6/3.8A	BS 1363A
WB2C	Double Waffle Baker	120V	1800	15.0A	NEMA 5-20P
		240V	1800	7.5A	NEMA 6-15P
WB2C-230EU		220/240V	1584 / 1800	7.2/7.5A	CEE7/VII
WB2C-230UK		220/240V	1584 / 1800	7.2/7.5A	BS 1363A
WB2WHNTB-120		120V	1800	15.0A	NEMA L5-20P

FEATURES & OPERATING CONTROLS

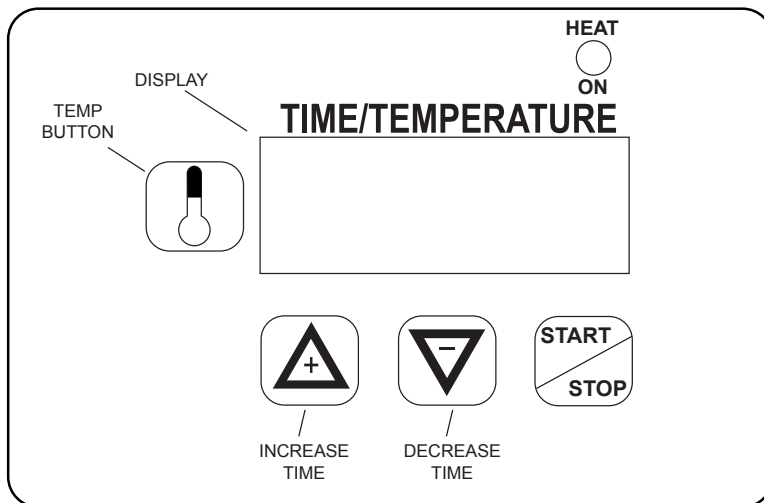
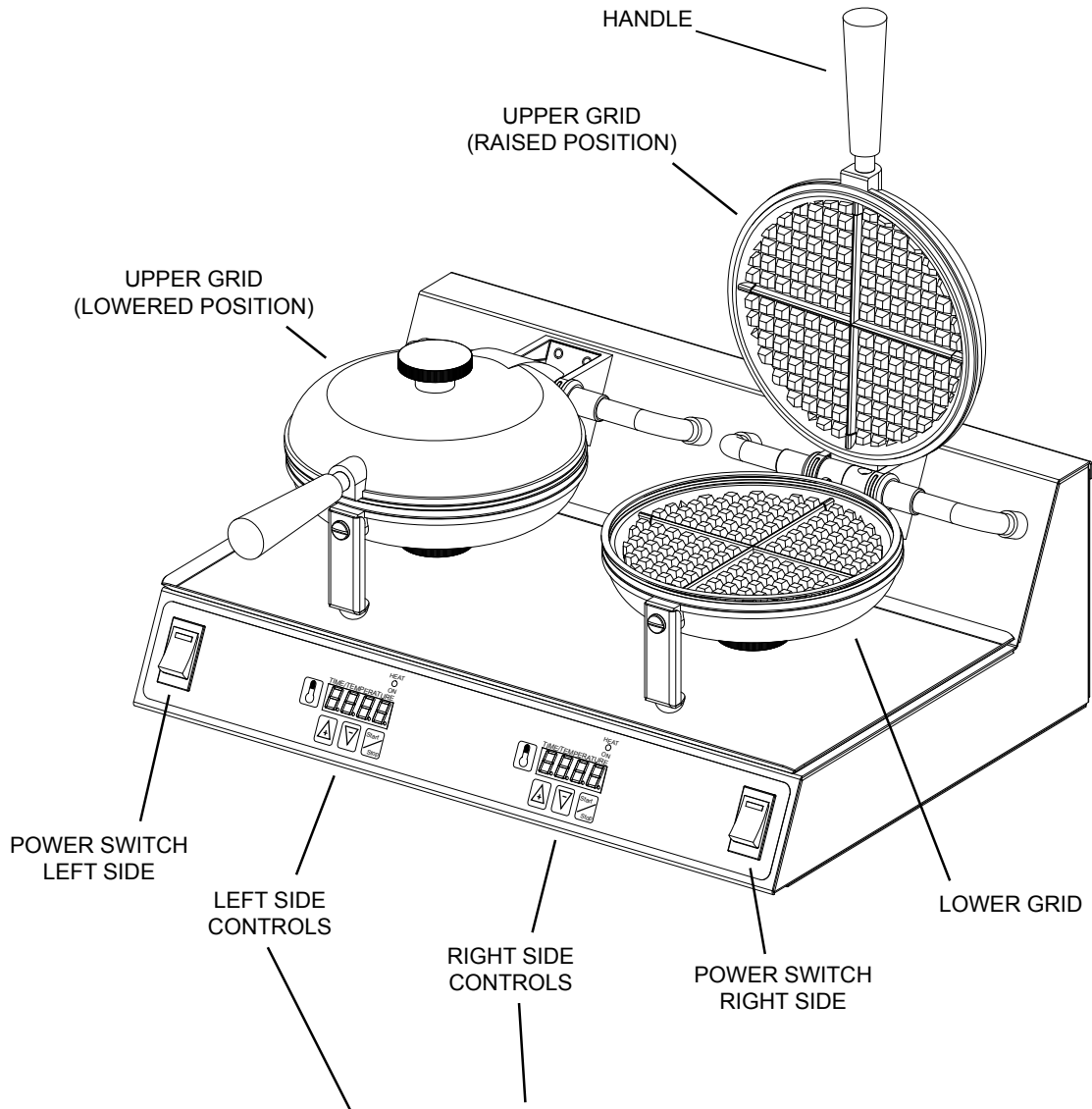

IL2642

M212 p/n 2M-Z17213 OpM WB1C & WB2C- Waffle Baker

PRECAUTIONS AND GENERAL INFORMATION



DANGER: BURN HAZARD

Contact with cooking grid surface will cause severe burns. Use the handle to lift the grid. Avoid contact with grid surfaces.



WARNING: ELECTRIC SHOCK HAZARD

All servicing requiring access to non-insulated components must be performed by qualified service personnel. DO NOT open any access panel that requires the use of tools. Failure to heed this warning may result in severe electric shock.

This appliance is intended for use in commercial establishments only.

This appliance is intended to prepare food for human consumption. No other use is recommended or authorized by the manufacturer or its agents.

Operators of this appliance must be familiar with the appliance use, limitations and associated restrictions. Operating instructions must be read and understood by all persons using or installing this appliance.

Cleanliness of this appliance is essential to good sanitation. Read and follow all included cleaning instructions and schedules to ensure the safety of the food product.

Disconnect this appliance from electrical power before performing any maintenance or servicing.

DO NOT submerge this appliance in water. This appliance is not jet stream approved. Do not direct water jet or steam jet at this appliance, or at any control panel or wiring. Do not splash or pour water on, in or over any controls, control panel or wiring.

Exposed surfaces of this appliance can be hot to the touch and may cause burns.

The technical content of this manual, including any wiring diagrams, schematics, parts breakdown illustrations and/or adjustment procedures, is intended for use by qualified technical personnel. Any procedure which requires the use of tools must be performed by a qualified technician.

This manual is considered to be a permanent part of the appliance. This manual and all supplied instructions, diagrams, schematics, parts breakdown illustrations, notices and labels must remain with the appliance if it is sold or moved to another location.

This appliance is made in the USA. Unless otherwise noted, this appliance has American sizes on all hardware.



CAUTION: RISK OF DAMAGE

DO NOT connect or energize this appliance until all installation instructions are read and followed. Damage to the appliance will result if these instructions are not followed.



CAUTION: HOT SURFACE

Exposed surfaces can be hot to the touch and may cause burns.

AGENCY LISTING INFORMATION

This appliance conforms to NSF Standard 4 for sanitation only if installed in accordance with the supplied Installation Instructions and maintained according to the instructions in this manual.

This appliance is U Listed under UL File E6070 for 120V.



STD 4



E6070

INSTALLATION

NOTE: DO NOT discard the carton or other packing materials until you have inspected the appliance for hidden damage and tested it for proper operation. Refer to SHIPPING DAMAGE CLAIM PROCEDURE on the inside front cover of this manual.



CAUTION: RISK OF DAMAGE

DO NOT connect or energize this appliance until all installation instructions are read and followed. Damage to the appliance will result if these instructions are not followed.



CAUTION: ELECTRICAL SHOCK HAZARD

The ground prong of the power cord is part of a system designed to protect you from electric shock in the event of internal damage to the appliance.

NEVER CUT OFF THE GROUND PRONG (large round prong). NEVER TWIST A PRONG TO FIT AN EXISTING RECEPTACLE.

Contact a licensed electrician to install an electrical receptacle appropriate to the voltage and amperage requirements of the waffle baker.

IMPORTANT:

Damage due to being connected to the wrong voltage or phase is NOT covered by warranty.

UNPACKING & INSPECTION

Carefully remove the appliance from the carton. Remove all protective plastic film, packing materials and accessories from the appliance before connecting performing any installation procedure.

Carefully read all instructions in this manual and the Installation Instruction Sheet packed with the appliance before starting any installation.

Read and understand all labels and diagrams attached to the appliance.

Carefully account for all components and accessories before discarding packing materials. Store all accessories in a convenient place for later use.

COMPONENTS

1 or 2 ea.	DRIP TRAY(S)
1 or 2 ea.	HANDLE(S)
4 ea.	ADJUSTABLE FEET

SETUP

Lightly lubricate threaded boss of upper grid using vegetable oil. Thread handle onto boss, making sure that they are fully seated. Handles are not removable once installed.

Setup the appliance only on a firm, level, non-combustible surface. Verify local codes for requirements. Concrete, tile, terrazzo or metal surfaces are recommended.

Install the provided adjustable feet, one on each corner of the appliance, in the holes provided. Verify that the unit sits firmly ON ALL FOUR FEET. Adjust as required to level the appliance. All four feet must be adjusted to firmly contact the countertop in order to prevent tipping.

ELECTRICAL INSTALLATION

Refer to the nameplate. Verify the electrical service power. Voltage and phase must match the nameplate specifications. Connecting the waffle baker to the wrong voltage can severely damage the unit or cause noticeably decreased performance.

IMPORTANT: Damage due to being connected to the wrong voltage is NOT covered by warranty.

SEASONING THE GRIDS

Lightly spray commercial waffle baker spray on both upper and lower grid.

Carefully close the upper grid. Turn the power switch ON, then allow the waffle baker to pre-heat for at least 20 minutes.

Using the handle, lift the upper grid and lightly re-coat both upper and lower grid. Lower the upper grid.

The appliance is now ready for use.

GENERAL OPERATIONAL NOTES

Carefully read the description of the waffle baker operation on the specification sheet.

DO NOT attempt to perform any maintenance or service unless the waffle baker is disconnected from electrical power.

DO unplug the waffle baker before cleaning, servicing or performing any maintenance.

DO NOT use sharp objects or metal implements to clean the grids.

DO use a plastic spatula or plastic scouring pad to remove burned-on food product.

OPERATION

Turn power switch to the ON position (alarm will sound 3-times)

With the upper grid closed, the preset time will flash the temp set-point, the alarm will sound 3-times when the temp set-point is reached.

Using the handle, lift the upper grid. Pour desired amount of waffle batter onto the lower grid.

Using the handle, carefully close the upper grid. Start timer by pressing the "Start/Stop" button.

When the alarm sounds, raise the upper grid and remove the waffle.

Cooking Recommendations:

- Keep the grids closed when not in use to maintain temperature.
- Use a soft bristle brush to lightly brush and clean cooking debris from the grids between waffles.
- Re-season grids every 3 - 4 waffles to guard against waffles sticking.
- This interval may be extended by adding oil or butter to the waffle batter.
- Always use fresh batter that contains sufficient shortening. Add shortening as necessary, and do not store batter for extended periods.
- Ensure a perfect, great-tasting waffle by cleaning and re-seasoning frequently. After every third waffle, and anytime the waffle baker has been left idle for over one-half hour, lightly spray grids with commercial waffle baker spray.
- Never apply beeswax, paraffin or other such materials to the grids. Use only a quality commercial waffle baker spray.
- Never use sharp implements (i.e. knives, forks, metal tongs) to remove waffles from the grid. Use a plastic spatula or plastic tongs.
- Do not store batter in the refrigerator and expect the same speed in baking. Cold batter will take longer to bake.



CAUTION: HOT SURFACE

Exposed surfaces can be hot to the touch and may cause burns.

IMPORTANT:

The timer bell will ring at the end of the cooking time. The timer bell is only a signal that the waffle is done. It does not turn the heating element on or off. Remove the waffle promptly when the bell rings.

CLEANING INSTRUCTIONS



CAUTION: BURN HAZARD

Allow waffle baker to cool completely before cleaning.

IMPORTANT: DO NOT spill or pour water into controls.

DO NOT submerge appliance in water. This will damage internal components. Damage to internal components from water is NOT covered by warranty.

DO NOT use steel wool or metal scouring pads to clean appliance or drip tray.

Good sanitation is vital to the quality of the final food product. Be sure to clean in all corners and crevices where grease and other cooking debris can accumulate.

PREPARATION

Unplug appliance from electric power
Allow appliance to cool completely.

FREQUENCY

Daily

TOOLS

Plastic Scouring Pad, Soft-Bristled Fiber Brush
Mild Detergent, Non-Abrasive Cleanser
Clean Soft Cloth / Sponge

CLEANING

1. Allow the waffle baker to cool to room temperature.
2. Clean grids by using a soft-bristle brush to remove any remaining cooking residue.
3. Clean the outside of the Waffle Baker by wiping it with a soft, clean cloth dampened with warm water and a mild detergent.
NEVER USE AN ABRASIVE CLEANSER.
4. Rinse by wiping with a soft, clean cloth dampened with clean water.
Allow to air dry.
5. Re-season the grids after cleaning by spraying with a commercial waffle baker spray.

Procedure complete

CLEANING INSTRUCTIONS

PREPARATION

Unplug appliance from electric power
Allow appliance to cool completely.

FREQUENCY

As needed

TOOLS

Commercial Carbon Cleaner
1" Bristle Brush, Stiff Fiber Brush
Clean Soft Cloth / Sponge



CAUTION: CHEMICAL BURN HAZARD

Waffle baker cleaner may cause serious burns on contact. Wear protective clothing and safety glasses when using waffle baker cleaner. Carefully read and follow directions and warnings on the label.



CAUTION: ELECTRIC SHOCK HAZARD

DO NOT submerge the waffle baker in water. If internal components become wet, the operator may suffer electrical shock, and the waffle baker will be damaged.

REMOVE CARBONIZATION FROM GRIDS

1. Allow the waffle baker to cool to room temperature.
2. Liberally apply a commercial carbon cleaning solution to the grids with a new 1" bristle brush. Be extremely careful when applying carbon cleaning solution to the grid surfaces. DO NOT spill any carbon cleaning solution or other caustic cleaning product on yourself or adjacent work surfaces.
IMPORTANT: Read and follow all manufacturer's instructions when using commercial carbon cleaners. Carbon cleaner can be hazardous. It is the operator's responsibility to use the product safely, in the manner directed by the carbon cleaner manufacturer.
3. Close the upper grid and allow the appliance to stand for several hours, or overnight, depending upon the extent of the carbonization.
4. Thoroughly remove the carbon cleaning solution and black residue using a fiber brush. Wipe down the grid surfaces carefully and thoroughly with water so that no carbon cleaning solution remains on the grids.
IMPORTANT: Make certain water and cleaner are not allowed to get into internal parts. The waffle baker will be damaged if internal components are allowed to get wet.
5. Clean the outside of the Waffle Baker by wiping it with a soft, clean cloth dampened with warm water and a mild detergent. NEVER USE AN ABRASIVE CLEANSER.
6. Rinse by wiping with a soft, clean cloth dampened with clean water. Allow to air dry.
7. Re-season the grids after cleaning by spraying with a commercial waffle baker spray.

Procedure complete

Use this procedure to clean any black residue (carbonization) remaining on the grids after the daily cleaning. Grids must be cleaned to remove the black residue, then re-seasoned, to ensure optimal performance

MAINTENANCE



CAUTION: BURN HAZARD

Exposed surfaces of the waffle baker may be hot to the touch and can cause burns. Waffle baker grids are very hot and will cause serious burns on contact.

Proper temperature for baking waffles is 385°F (196°C). Variations in altitude and/or batter mix may require a slightly different temperature for best results.

CHANGING FROM °F TO °C

Hold “TEMP” button and turn “OFF” and then “ON” the lighted switch on the front panel. To change back from °C to °F, repeat the same procedure.

CHECKING TEMPERATURE

Hold “TEMP” button to display the current temperature



SETTING THE TIME

If necessary, the factory pre-set timer can be adjusted to satisfy individual preferences.



To Increase Time: Press & hold the “UP” button, then press the “Start/Stop” button the amount you wish to increase the cooking time.



To Decrease Time: Press & hold the “DOWN” button, then press the “Start/Stop” button the amount you wish to decrease the cooking time.

TROUBLESHOOTING

SYMPTOM	POSSIBLE CAUSE	SUGGESTED REMEDY
Will not heat	Power cord not plugged in, or circuit breaker tripped.	Establish main power. Be sure appliance is plugged in
	Power Switch “OFF”	Turn power switch “ON”
	Internal component damaged	Contact an authorized Wells Service Agency for repair
Does not maintain temperature	Excessive carbonization of grids	Decarbonize grids
	Internal component damaged	Contact an authorized Wells Service Agency for repair

WIRING DIAGRAM: WB1C 120V

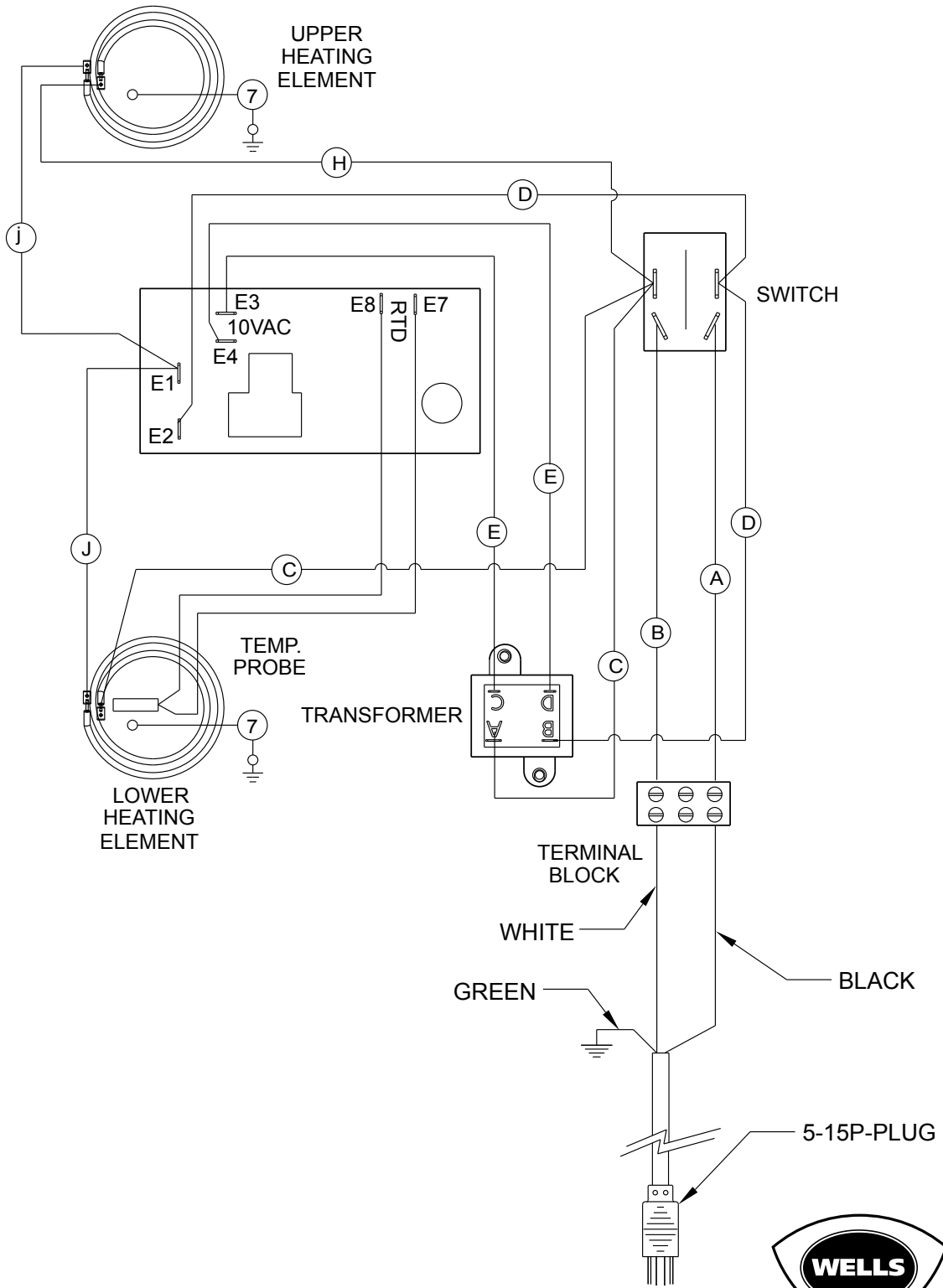

M212 p/n 2M-Z1T213 OpM WB1C & WB2C- Waffle Baker

MODEL WB1C, SINGLE WAFFLE BAKER- CANTILEVER WIRE DIAGRAM, 120V

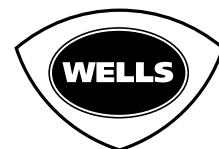

SK2634 01/10/13

WIRING DIAGRAM: WB1C, 208/240V, 220/240V

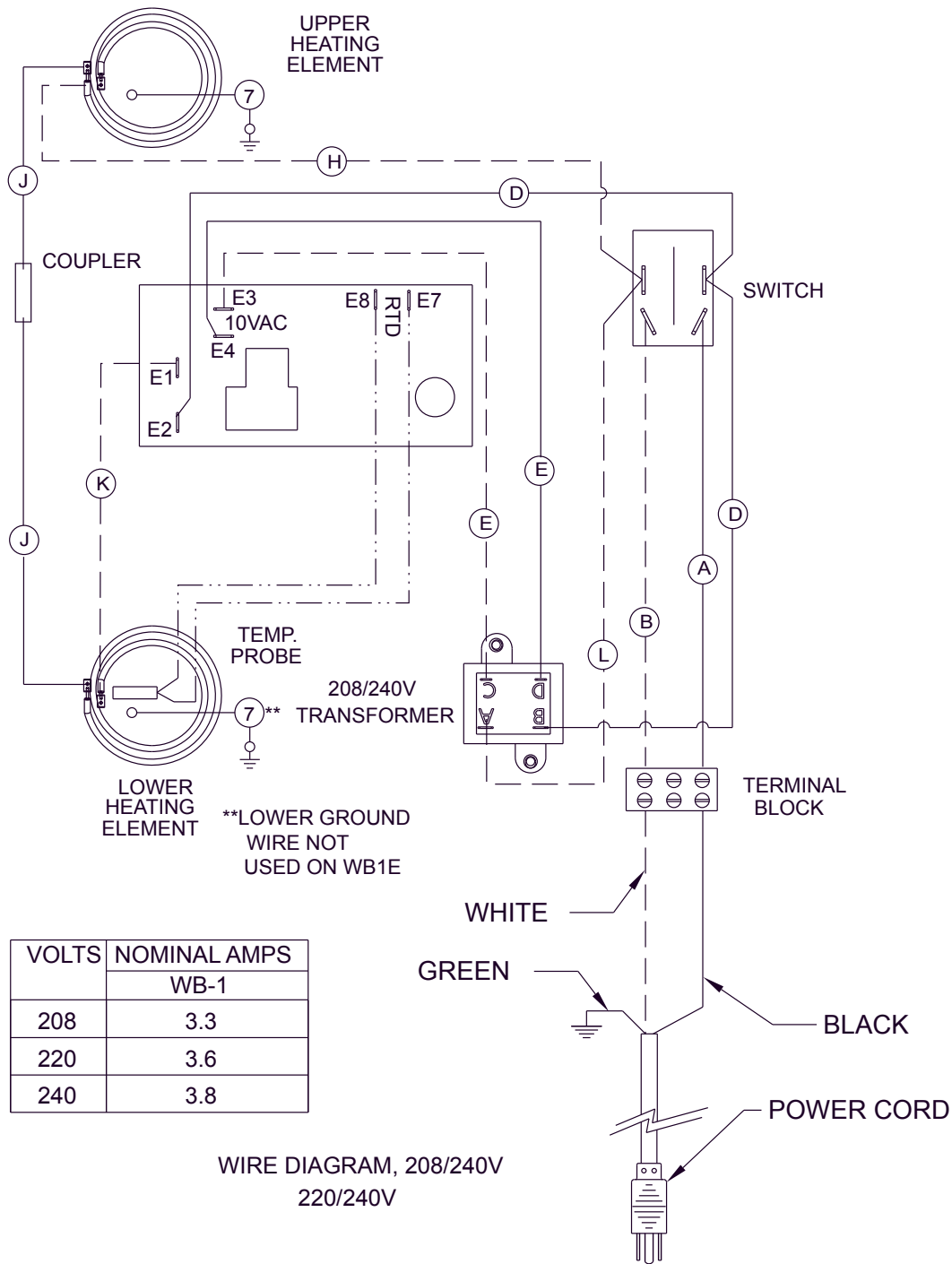

MODELS: WB1C, SINGLE WAFFLE BAKER- CANTILEVER DESIGN - ELECTRONIC CONTROLS - 208/240V, 220/240V
WB1E, SINGLE STD. WAFFLE BAKER- ELECTRONIC CONTROLS - 208/240V, 220/240V

SK2695 10/16/13 REV (-)

M212 p/n 2M-Z17213 OpM WB1C & WB2C- Waffle Baker

WIRING DIAGRAM: WB2C

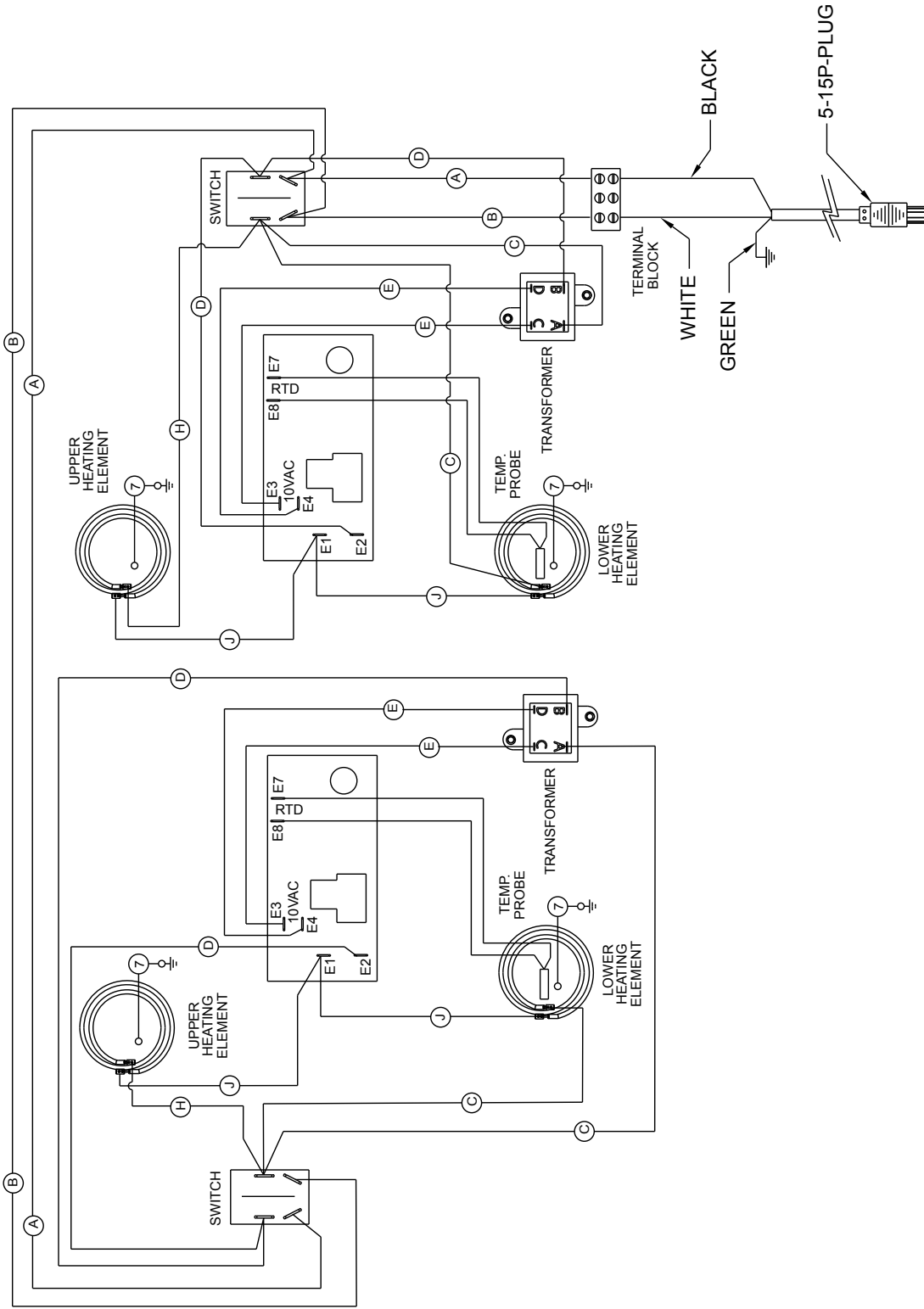

WIRE DIAGRAM - WB2C-120V
WELLS TWIN WAFFLE BAKER CANTILEVER.

WELLS MANUFACTURING INC.
SK2639 REV. -- 2/11/12

EXPLODED VIEW: ELECTRONICALLY CONTROLLED WAFFLE BAKER

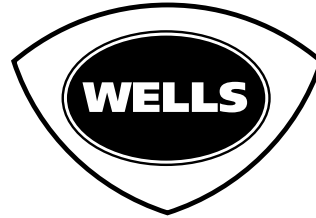

Model: WB1C, Electronic Waffle Baker

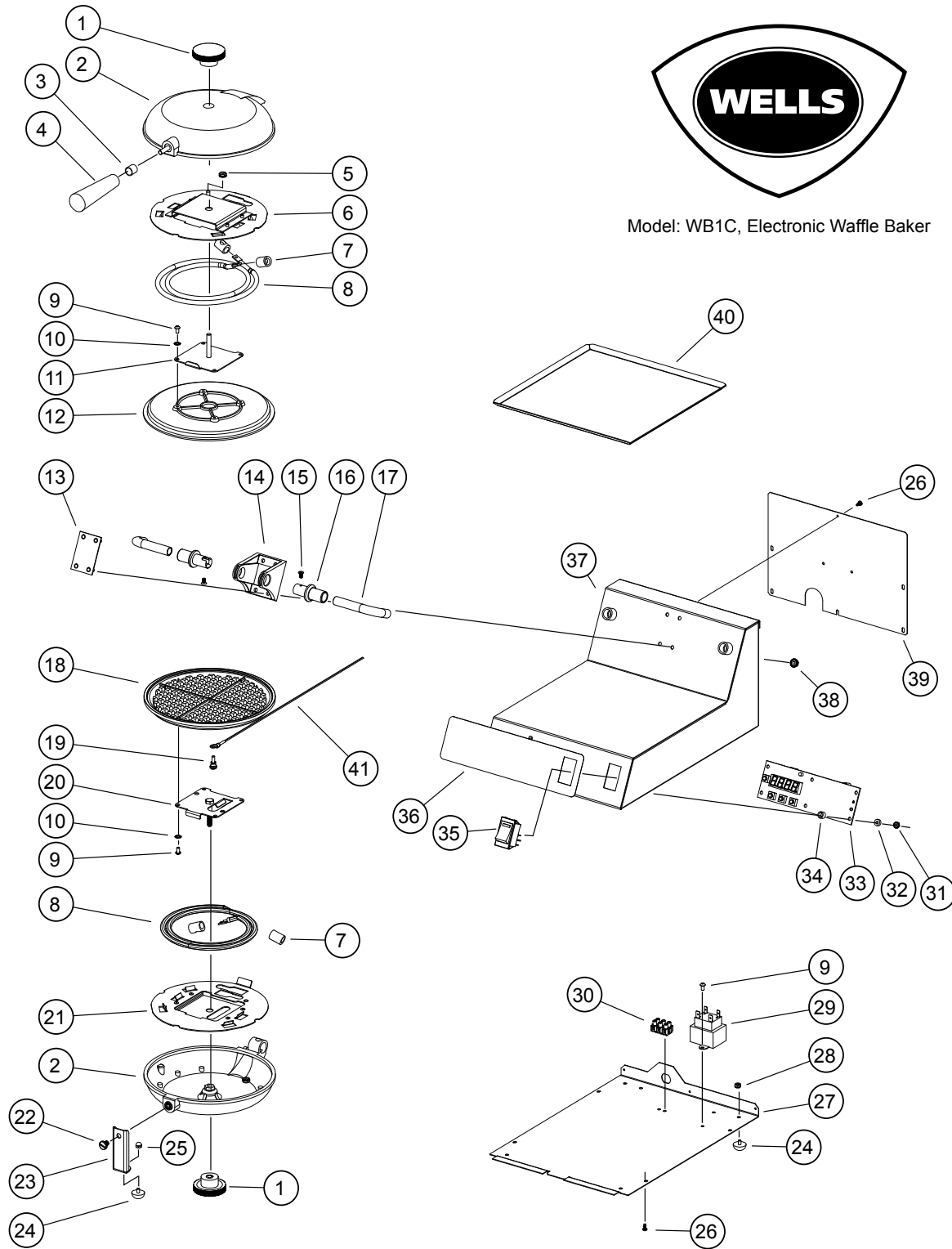

M212 p/n 2M-Z17213 OpM WB1C & WB2C- Waffle Baker

SK2670, Rev A, 3/17/14

PARTS LIST

Model: WB1C & WB2C Waffle Baker w/ Electric Control

Fig No.	Part Number	Qty	Description	Application
1	2R-09-WB-0015	2	KNOB BLACK PHENOLIC	WB1C
		4		WB2C
2	2F-Z15888	2	TOP/BOTTOM CASTING-MACH'D	WB1C
		4		WB2C
3	2V-Z17056	1	SPACER-1/2 TUBE X 1/2 SS	WB1C
		2		WB2C
4	2R-Y6762	1	HANDLE-DIMCO GRAY 190	WB1C
		2		WB2C
5	2C-08-07-0207	2	NUT 10-24 HEX STL NP	WB1C
		4		WB2C
6	B8-WL0311	1	ASY-ELEMNT MOUNTING UPPER	WB1C
		2		WB2C
7	2K-307280	4	BUSHING ELEM TERM INSULAT	WB1C
		8		WB2C
8	2N-307811UL	2	ELEM 120V 450W + 2 TERM S	WB1C
		4		WB2C
9	2C-31715	10	SCREW 8-32X5/16 PH RD HD	WB1C
		20		WB2C
10	2C-1825	8	WASHER #8 EXT STL NP	WB1C
		16	WASHER #8 EXT STL NP	WB2C
11	B8-WL0359	1	ASM-WELD-UPR GRID MTG BRT	WB1C
		2		WB2C
12	2F-38917	1	GRID TOP CAST AND MACH AS	WB1C
		2		WB2C
13	B8-WL0303	1	ASY-HINGE MOUNTING PLATE	WB1C
		2		WB2C
14	2F-Z15902	1	HINGE, WB1&2, W/4HOLES	WB1C
		2		WB2C
15	2C-Z16041	2	SCREW 8-32X5/16 FLT PH SS	WB1C
		4		WB2C
16	2F-Z15908	2	CONDUIT CASTING	WB1C
		4		WB2C
17	2K-Z15801	2	CONDUIT-90 DEG-1/2" TUBE	WB1C
		4		WB2C
18	2F-307657	1	GRID BOTTOM CAST/MACHINED	WB1C
		2		WB2C
19	2C-Z16039	1	SCREW, THUMB 8-32X3/8 SS	WB1C
		2		WB2C
20	B8-WL0313	1	ASY-WELD LWRGRID MTG BRKT	WB1C
		2		WB2C
21	B8-WL0312	1	ASY-ELEMNT MOUNTING LOWER	WB1C
		2		WB2C
22	2C-Z16666	1	SCREW-1/4-20X3/8 PN SL SS	WB1C
		2		WB2C
23	B8-Z15895	1	BRACKET-LOWER SUPPORT	WB1C
		2		WB2C

M212 p/n 2M-Z17213 OpM WB1C & WB2C- Waffle Baker

March 4, 2014, Rev. A

PARTS LIST

Model: WB1C & WB2C Waffle Baker w/ Electric Control				
Fig No.	Part Number	Qty	Description	Application
24	2A-45728	5	FOOT RUBBER LLW LLF	WB1C
		6		WB2C
25	2C-200200	1	NUT 8-32 ACHD BRS NP	WB1C
		2		WB2C
26	2C-33935	10	SCREW 6ABX5/16 PH PAN SMS	WB1C
		16		WB2C
27	B8-Z16660	1	PANEL, BOTTOM WB2C	WB2C
	B8-Z16668		PANEL, BOTTOM-WB1C	WB1C
28	2C-31053	6	NUT 8-32 KEPS MS NICKEL	WB1C
		8		WB2C
29	2E-05-07-0351	1	TRANSFORMER 115/10V 6VA	WB1C-120V
		2		WB2C-120V
	2E-05-07-0350	1	TRANSFORMER 230V/10V 6VA	WB1C-240V, WB1C-230EU, WB1C-230UK
		2		WB2C-240V, WB2C-230EU, WB2C-230UK
31	2C-2553	6	NUT 6-32 HEX STL NP	WB1C
		12		WB2C
32	2K-08-07-0004	6	SPACER ROUND NYLON	WB1C
		12		WB2C
33	B8-Z16898	1	TIMER/TEMP CONTRL WB1C/2C	WB1C
		2		WB2C
34	2K-Z1971	6	SPACER .257X.75X.25 NYLON	WB1C
		12		WB2C
35	2E-35127	1	SWITCH ROCK PLAS BEZEL W/	WB1C
		2		WB2C
36	2M-Z16571	1	OVERLAY-TIME/TEMP WB2C	WB2C
	2M-Z16572		OVERLAY, TIME/TEMP WB1C	WB1C
37	B8-WL0351	1	ASU-BODY-WB2C	WB2C
	B8-WL0352		ASM-BODY-WB1C	WB1C
38	2C-Z2893	4	NUT 10-24 HEX STL ZP	WB1C
		8		WB2C
39	B8-Z16661	1	PANEL, REAR-WB2C	WB2C
	B8-Z16669		PANEL, REAR-WB1C	WB1C
40	B8-Z15901	1	TRAY-DRIP-WB2C	WB2C
	B8-Z16677		TRAY-DRIP-WB1C	WB1C
41	2J-307279	1	PROBE, TEMP	WB1C
		2		WB2C
NI	2E-34538	1	CORD SET 125V NEMA 5-20P	WB2C-120V
	2E-35539		CORD SET 120V 15A 16GA 4F	WB1C-120V
	2E-35540		CORD SET 6-15P 16/3W 4FT	WB1C-240V, WB2C-240V
	K3-WL0401		CORD ASSY UK 48" #8RNG	WB1C-230UK, WB2C-230UK
	D5-MDW088		CORDSET ASSY.,CEE7/VII	WB2C-230EU
	2E-72920		CORD & CAP EURO 3COND CE	WB1C-230EU

M212 p/n 2M-Z17213 OpM WB1C & WB2C- Waffle Baker

PARTS LIST

Model: WB1C & WB2C Waffle Baker w/ Electric Control				
Fig No.	Part Number	Qty	Description	Application
NI	2K-7889	1	BUSHING HEYCO SR-11-2	120V, 240V
	2K-31217		STRAIN RELIEF 90DEG HEYCO	WB1C-120V
	2K-70648		STRAIN RELIEF SMALL	230EU, 230UK
	2K-76118		STRAIN RELIEF STR	WB2C-230EU, WB2C-230UK
NI	B8-Z16899	1	WIRE ASSY "A" -WB2C	WB2C-120V
	B8-Z16900		WIRE ASSY "A" -WB2C	WB2C-120V
	B8-Z16901		WIRE ASSY "A" -WB1C	WB1C-120V
NI	B8-Z16902	1	WIRE ASSY "B" - WB1C	WB1C-120V
NI	B8-Z16903	1	WIRE ASSY "C" WB1C/2C	WB1C-120V
		2		WB2C-120V
NI	B8-Z16904	1	WIRE ASSY "D" WB1C/2C	WB1C
		2		WB2C
NI	B8-Z16905	2	WIRE ASSY "E" WB1C/2C	WB1C
		4		WB2C
NI	B8-Z16906	2	WIRE ASSY "J" WB1C/2C	WB1C
		4		WB2C
NI	B8-Z16948	2	WIRE ASSY-GROUND-18"	WB1C
		4		WB2C
NI	B8-Z16949	1	WIRE ASSY "H"-WB1C/2C	WB1C
		2		WB2C
NI	B8-Z17585	1	WIRE ASSY "K" WB1C/2C240V	WB1C-240V, WB1C-230EU, WB1C-230UK
		2		WB2C-240V, WB2C-230EU, WB2C-230UK
NI	B8-Z17586	1	WIRE ASSY "L" WB1C/2C240V	WB1C-240V, WB1C-230EU, WB1C-230UK
		2		WB2C-240V, WB2C-230EU, WB2C-230UK

NOTES

PARTS & SERVICE

DESCRIPTION

PART NO.

IMPORTANT: Use only factory authorized service parts and replacement filters.

For factory authorized service, or to order factory authorized replacement parts, contact your Wells authorized service agency, or call:

Wells Manufacturing
10 Sunnen Dr.
St. Louis MO 63143 USA

Service Dept.
phone: (314) 678-6314
fax: (314) 781-2714

Service Parts Department can supply you with the name and telephone number of the **WELLS AUTHORIZED SERVICE AGENCY** nearest you.

CUSTOMER SERVICE DATA

please have this information available if calling for service

RESTAURANT _____ LOCATION _____

INSTALLATION DATE _____ TECHNICIAN _____

SERVICE COMPANY _____

ADDRESS _____ STATE _____ ZIP _____

TELEPHONE NUMBER (____)____-_____

EQUIPMENT MODEL NO. _____ EQUIPMENT SERIAL NO. _____

VOLTAGE: (check one) 208 240



Wells Bloomfield proudly supports CFESA
Commercial Food Equipment Service Association

SERVICE TRAINING - QUALITY SERVICE



CUSTOMER SATISFACTION



WELLS MANUFACTURING
10 Sunnen Dr., St. Louis, MO 63143
telephone: 314-678-6314
fax: 314-781-2714
www.wellsbloomfield.com